

 **Roland**

MIDI LINEAR SYNTHESIZER

D-50

Owner's Manual

ADVANCED

ADVANCED COURSE

CONTENTS

1 Outline of Tone Parameters	3	5 MIDI	51
1. The Basic Concept of a Tone	3	1. Connection	51
2. Structure of Tone Parameters	5	2. Setting MIDI Functions	51
a. WG	7	a. MIDI Functions commonly set for all Patches	52
b. TVF	7	b. MIDI Functions individually set for each Patch	56
c. TVA	7	3. Key Mode Alteration	57
d. ENV	8	4. Data Transfer with MIDI	61
e. LFO	8	6 Data Transfer with Memory Card	65
2 Editing	9	1. Patch Transfer	65
1. Calling a Parameter	9	a. Patch Transfer to the Memory Card	65
2. Changing Values	11	b. Patch Transfer to the Internal Memory	66
a. Local Editing	11	2. Copying a Reverb Type	68
b. Ten Key Pad	13	a. Copying from a Memory Card to the D-50	68
3. Useful Functions for Editing	14	b. Copying from the D-50 to a Memory Card	69
a. Compare	14	7 Appendix Tables	70
b. Undo	14	1. Patch Factor Table	70
c. Copy	14	2. Tone Parameter Table	71
d. Partial Mute	17	a. Common Parameters	71
e. Partial Balance	17	b. Partial Parameters	72
4. Sound Creation	19	3. MIDI Function Table	73
5. Naming	20	4. Error Message Table	74
3 Tone Parameters	22	5. Sample Note	75
1. Common Parameters	22		
a. Structure	22		
b. P-ENV	23		
c. Pitch Modulation	25		
d. LFO	26		
e. Equalizer	27		
f. Chorus	29		
2. Partial Parameters	30		
a. WG Pitch	30		
b. WG Modulation	32		
c. WG Waveform	33		
d. WG Pulse Width	35		
e. TVF	36		
f. TVF ENV	39		
g. TVF Modulation	42		
h. TVA	43		
i. TVA ENV	44		
j. TVA Modulation	47		
4 Writing	48		

1 OUTLINE OF TONE PARAMETERS

1. THE BASIC CONCEPT OF A TONE

A Tone consists of two Partials (Partial 1 and 2) and a Common block.

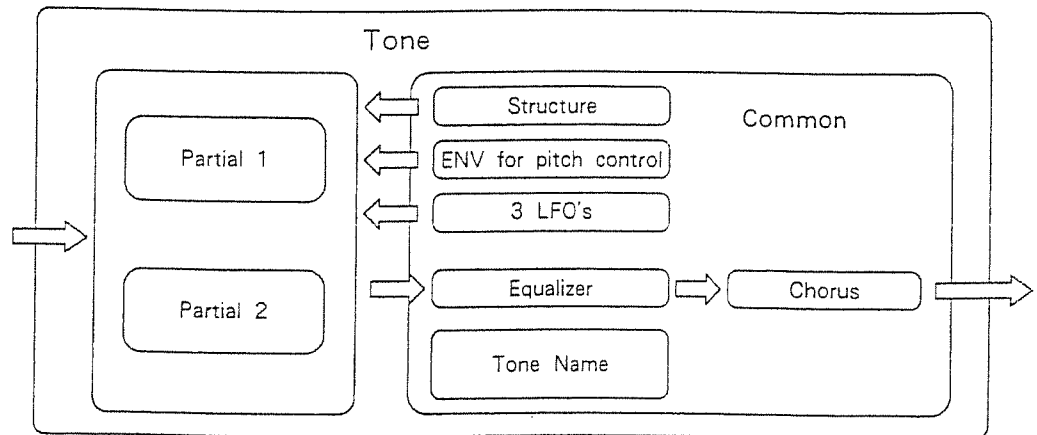

Each Partial (Partial 1 and Partial 2) can have one of two sound generators (a **Synthesizer sound source** or a **PCM sound source**). So you can think of the D-50 having powerful synthesizers built in. Each of these hypothetical synthesizers could behave like a conventional analog synthesizer, or a PCM sampled synthesizer. Any combination of two synthesizers can achieve some remarkable cross-modulation effects, so characteristic of today's purely digital sounds.

Some Common parameters apply to both Partials (Partial 1 and 2). "**Structure**" is one of the Common parameters. It decides which of the two sound generators is used for each Partial. Other Common parameters are an ENV for pitch, three LFO modules, equalizer, chorus, etc.

[STRUCTURE]

Structure, which is one of the Common parameters, determines which two of the hypothetical synthesizers (a synthesizer sound generator or a PCM sound generator) are to be used as Partial 1 and Partial 2.

A "Synthesizer sound generator" works like a conventional analog type synthesizer with an oscillator, a filter, an amplifier and two ENV's. A PCM sound generator provides 100 different PCM sampled sounds.

These two Partial sounds (Partial 1 and Partial 2) can simply be mixed as shown below.

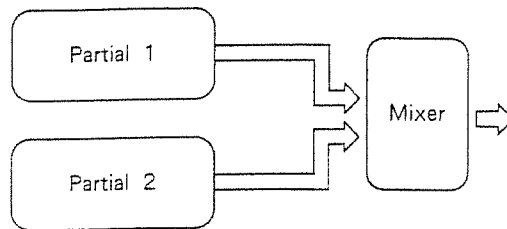

By mixing two Partials, fatter sounds can be obtained. This is effective for making strings or organ type sounds.

Or Partial 1 can be mixed with the ring-modulated sound of Partials 1 and 2.

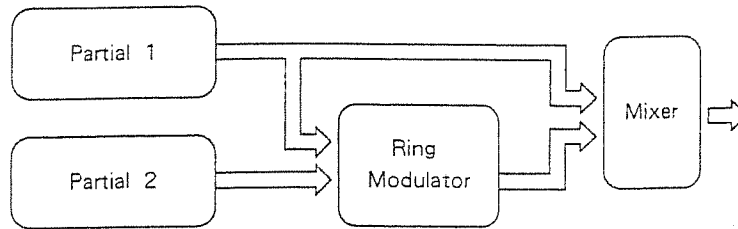

The Ring Modulator multiplies two sounds, creating an unusual and metallic sound that contains complicated harmonics. For instance, two waveforms (① and ②) are multiplied and waveform ③ is created. This is effective for making metallic sounds.

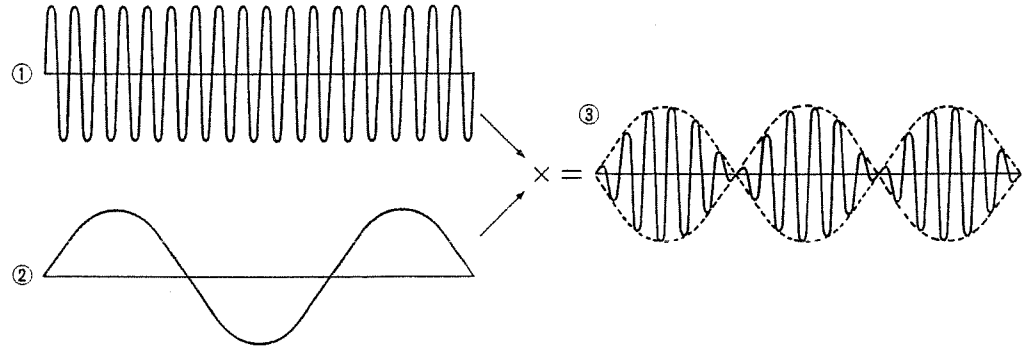

2. STRUCTURE OF TONE PARAMETERS

Depending on which generators are selected in the Partial Block, greatly different Tone Parameters will be used. Some Tone Parameters used for the Synthesizer sound generators are irrelevant to the PCM generator (see the diagram below).

In a Structure with Ring modulation, some parameters of Partial 2 are automatically set to those of Partial 1. See page 22 "Tone Parameters" for a detailed explanation.

OUTLINE OF TONE PARAMETERS

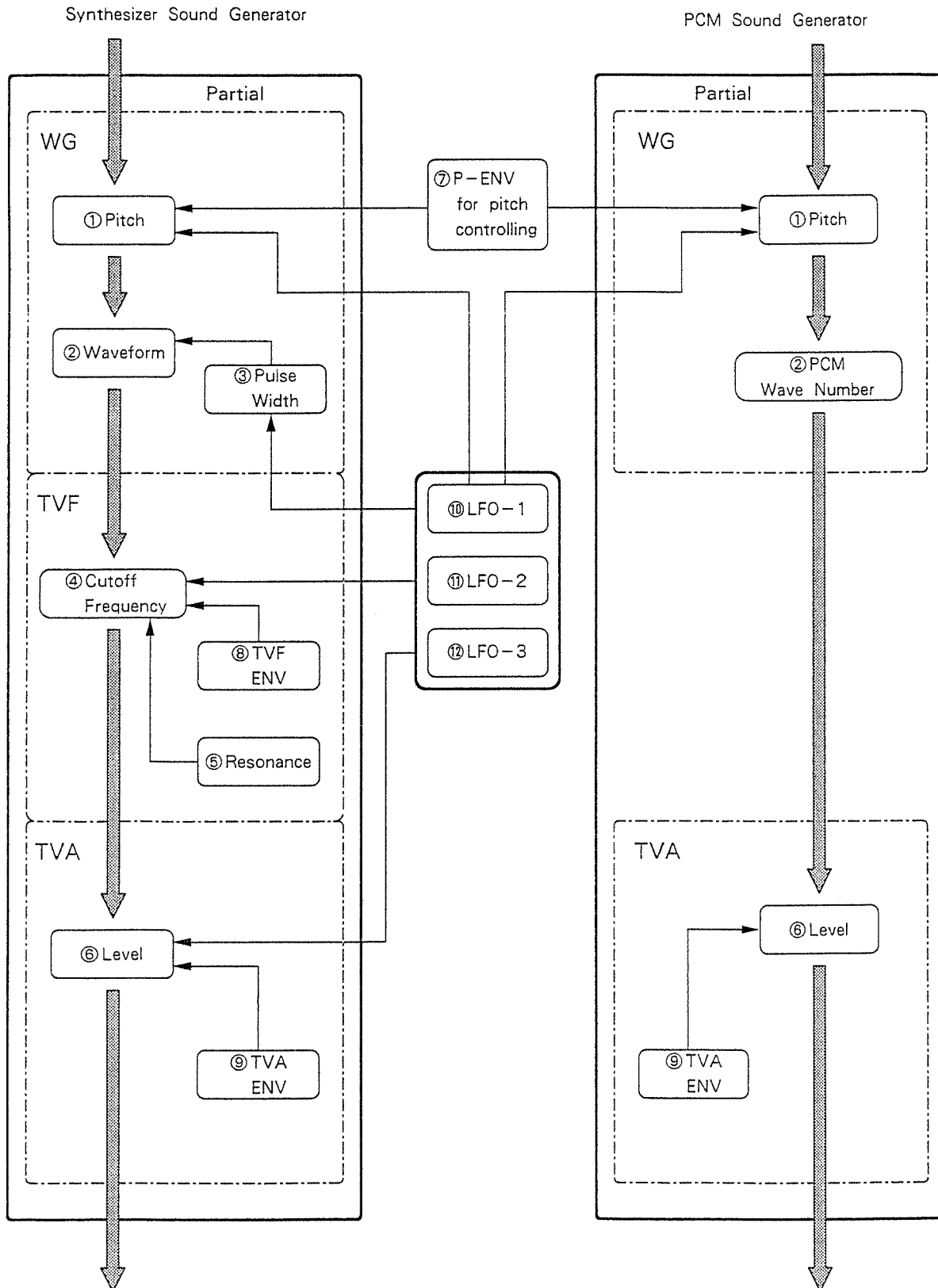

a. WG (Wave Generator)

In the WG (Wave Generator), the pitch and waveform are controlled.

① Pitch

The basic pitch of a Partial (sound generator) can be set here. The pitch is a Common parameter, and is therefore controlled by ⑦ P-ENV and ⑩ LFO-1.

② Waveform (PCM Wave Number)

This selects the waveform of the sound source. When a synthesizer sound generator is selected, the waveform can be controlled by the ③ Pulse Width controls.

③ Pulse Width

This changes the waveform of the sound source. The pulse width is controlled by any LFO (=Common parameter).

b. TVF (Time Variant Filter)

This filter passes lower frequency harmonics and cuts off the higher ones. By changing the cutoff point and the resonance, the waveform changes.

④ Cutoff Frequency

This sets the cutoff point. The cutoff point can be controlled by ⑧ TVF ENV and any LFO (=Common parameter).

⑤ Resonance

This emphasizes the cutoff point, making more unusual or electronic sounds.

c. TVA (Time Variant Amplifier)

This controls the volume of the Partial.

⑥ Level

This determines the volume of the sound. When a synthesizer sound generator is used, the level can be controlled with the ⑨ TVA ENV and any LFO (Common parameter). When a PCM sound generator is used, the ⑨ TVA ENV controls the level.

d. ENV (Envelope Generator)

This generates a control signal (envelope curve) which controls the pitch, timbre and volume of each Partial (sound generator).

⑦ P-ENV

This is the ENV which controls pitch. It can be set for two selected Partial at once.

⑧ TVF ENV

This ENV controls the cutoff point, and can be set for each Partial separately.

⑨ TVA ENV

This ENV controls the volume level. This can be set for each Partial separately.

e. LFO (Low Frequency Oscillator)

This oscillator generates low frequencies only.

Any of the three LFO's can be used for the two Partials, Vibrato, PWM growl or tremolo effects can be obtained using these LFO's.

*A different LFO can be used for each section or a PARTIAL.

⑩ LFO-1

This can control ① Pitch, ③ Pulse Width, ④ Cutoff Frequency or ⑥ Level.

⑪ LFO-2

This can control ③ Pulse Width, ④ Cutoff Frequency or ⑥ Level.

⑫ LFO-3

This can control ③ Pulse Width, ④ Cutoff Frequency or ⑥ Level.

2 EDITING

The D-50 features various parameters which can be edited, thereby synthesizing new sounds. However, it does not feature knobs or switches on its front panel. Instead, there are two methods of editing: one is achieved by calling each parameter with the relevant buttons, and changing the value with the Joystick, or Increment and Decrement Buttons, the other is by using the optional programmer PG-1000, which has all the necessary panel controls.

For quicker and easier editing or synthesizing from scratch, the PG-1000 may be essential.

*The editing procedure does not automatically rewrite the existing program, the appropriate writing procedure, on page 18 must be taken.

1. CALLING A PARAMETER

A number of Patch Factors and Tone Parameters are shown in a Menu Display at the same time. There are several Menu Displays as shown below. Each parameter shown in a Menu Display contains

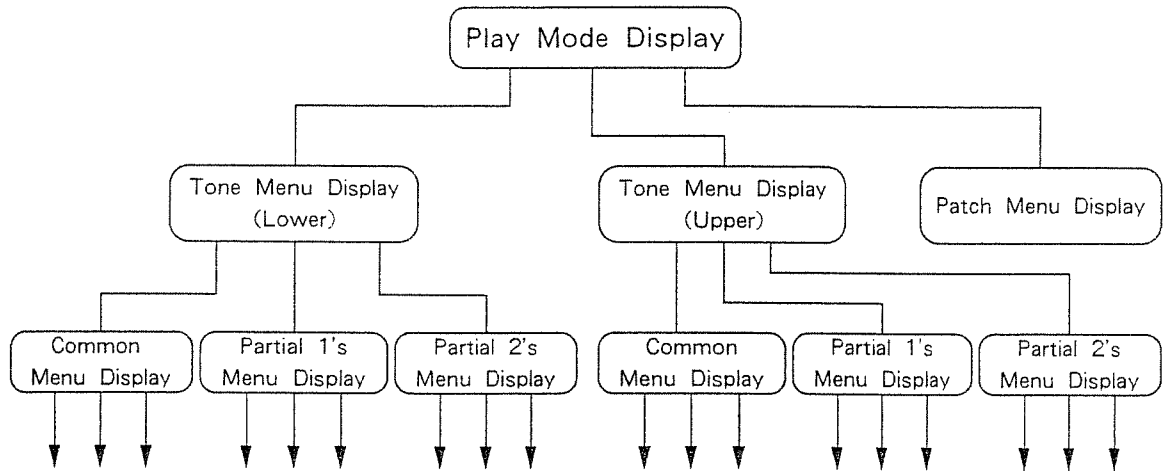

several more parameters.

You can select any parameter you want by using the corresponding Selector Button or Scroll Button.

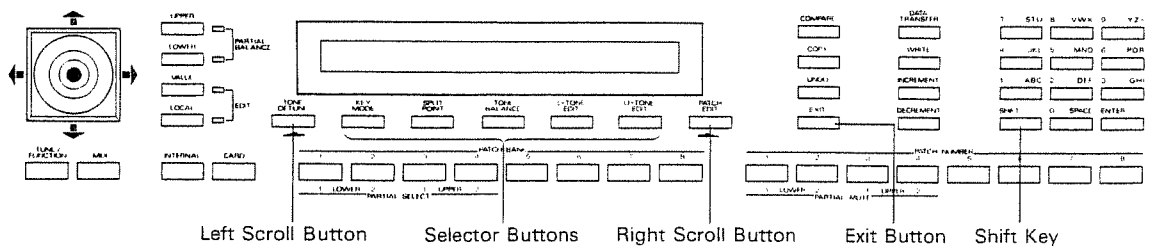

The following explains how each button works. The Menu Display and parameter which each button leads to are shown in the supplied Edit Map. Please thoroughly study the map.

● **Selector Buttons**

These can be used to select one of the parameters shown in the Display. Simply push the relevant Selector Button, and its current value will flash in the Display.

● **Scroll Buttons**

These buttons can be used to scroll through more parameters in the same menu group.

Pushing the far-right Scroll Button calls the next parameter group, and the left Scroll Button returns to the previous parameter group.

● **Exit Button**

This button can be used to leave the parameter currently called and go back to its Menu Display. To go back to the Play Mode Display, hold down the Shift Key while pressing the Exit Button.

[CHANGING PARTIAL DISPLAYS]

While editing a parameter of one Partial, you can call the Display of the same parameter for a different Partial.

The Patch Buttons 1 to 4 can select Partials as shown below.

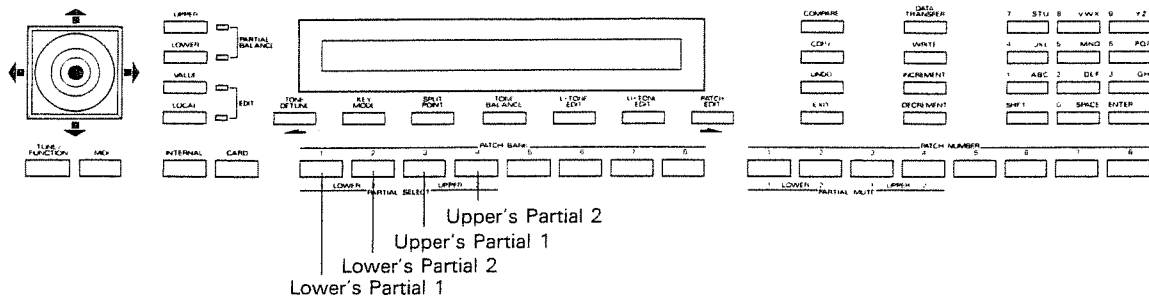

2. CHANGING VALUES

Normally, the Joystick is used to change the value drastically, and the Increment and the Decrement Buttons for fine adjustment.

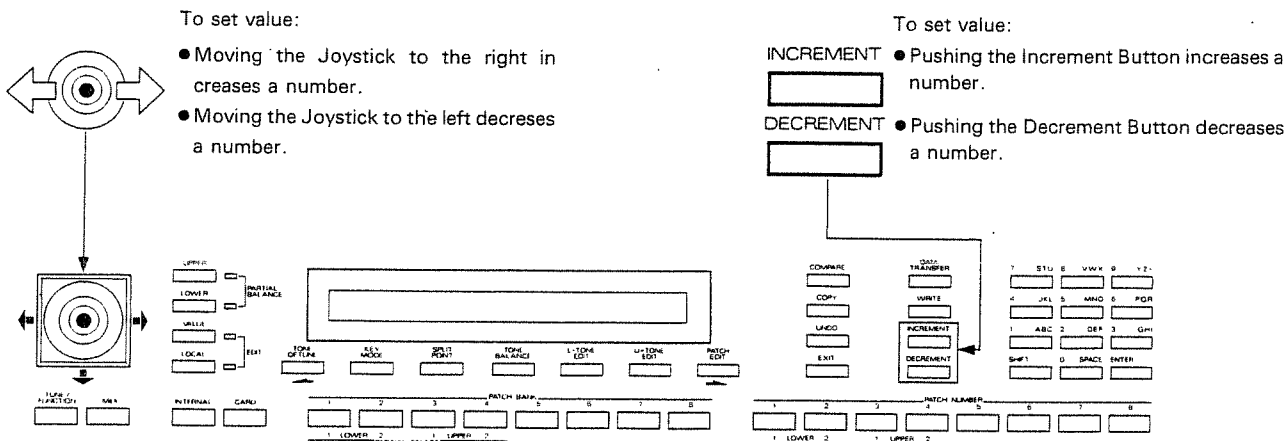

The following are rather special ways of changing values.

a. Local Edit

This function allows you to change the values of two adjacent parameters at the same time with the Joystick. This can be effectively used for simultaneously changing two values which affect one another.

[e.g.] **Tone Detune (Fine Tuning of the Upper and the Lower Tones)**

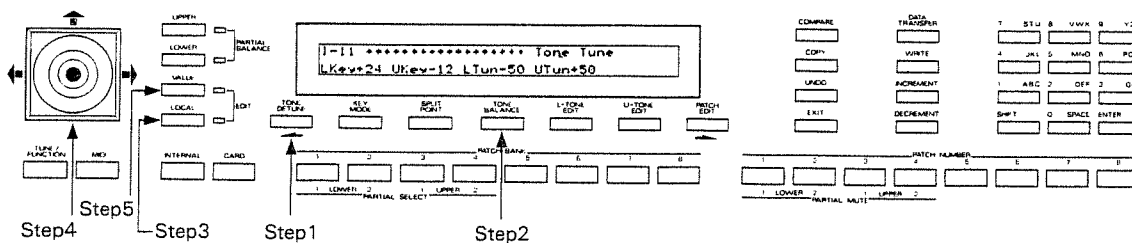

- Step 1 Push the far-left Scroll Button (TONE DETUNE) to change to the Display you want.
- Step 2 Assign the left parameter (Lower Tone) of the two adjacent parameters with the corresponding Scroll Button.
- Step 3 Push the LOCAL Button. (The indicator lights up.)
- Step 4 With the Joystick, change the value.

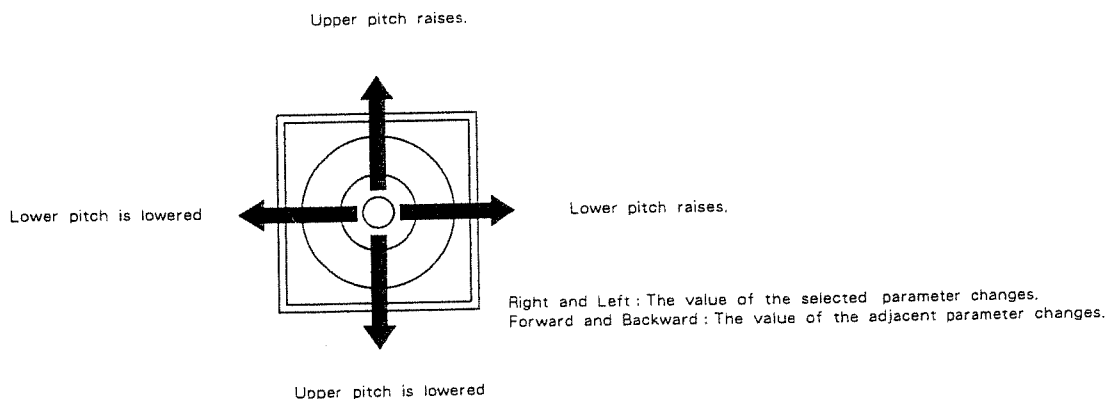

When the Joystick is returned to the center position, the value returns to the original value. The variable range is narrow so that the value can be subtly adjusted.

*When there is no parameter to the right of the parameter assigned with the Selector Button in step 2, only the assigned parameter is edited.

- Step 5 To return the Joystick to its normal function, push the VALUE Button.

3. USEFUL FUNCTIONS FOR EDITING

a. Compare

While editing a parameter, you may wish to hear the original sound before it was edited. The D-50's Compare function allows you to call the original Patch without erasing the edited sound.

Step 1 Push the Compare Button once.



The Display responds as shown below, and the original sound may be heard by playing the keyboard.

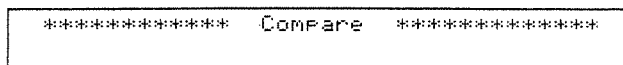

Step 2 Push the Compare Button again, and the edited sound will come back.

In this Compare mode, the edited sound is temporarily saved, and therefore remains even after calling a different Patch. (This does not apply when the D-50 is turned off.) Hold the Compare Button down while pushing the Shift Key, and the edited sound will be recalled.

***When the Display shows the Compare mode indication, editing cannot be achieved.**

b. Undo

The Undo function returns the current value of the parameter to the original value before being edited. This only refers to the last parameter that has been adjusted.

Simply push the Undo Button.



c. Copy

The Copy function can copy the parameters of a Tone or Block to a different location.

● Tone Copy

A Tone from another Patch can be copied to the Patch currently selected.

Step 1 By pushing the appropriate Selector Button, call the Tone Copy Display. (With the aid of the Edit Map, take the following procedure.)

To copy to the Upper Tone, call the Upper Tone Menu Display, then push the far-right Selector Button.

To copy to the Lower Tone, call the Lower Tone Menu Display, then push the far-right Selector Button.

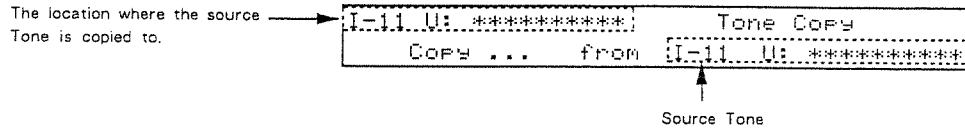

Step 2 While actually playing the keyboard, select the Tone to be copied (Source Tone), and it will be copied to the Tone of the currently selected Patch.

Select either the Upper or the Lower Tone. (Holding the button down will change Patch numbers at the same time.)

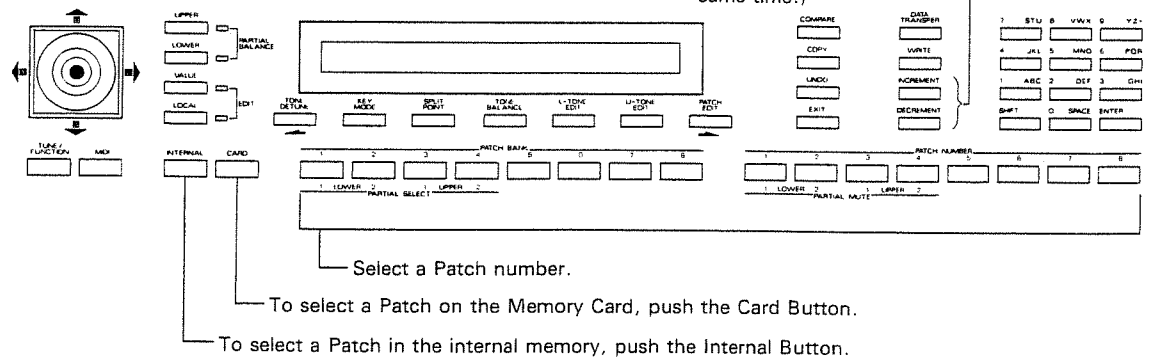

At this stage changing the Display will show the Tone Name just copied.

● **Block Copy**

A group of Tone Parameters can be copied within a Patch.

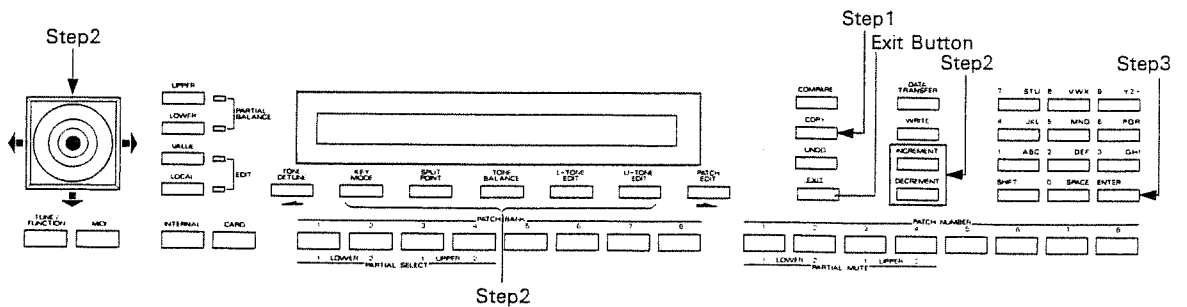

- Step 1 Push the Copy Button.
- Step 2 Push the relevant Selector Button first, and select a source Tone, and the Block to be copied, then the destination Tone and its Block using the Joystick or Increment and Decrement Buttons as shown below ① - ⑤.

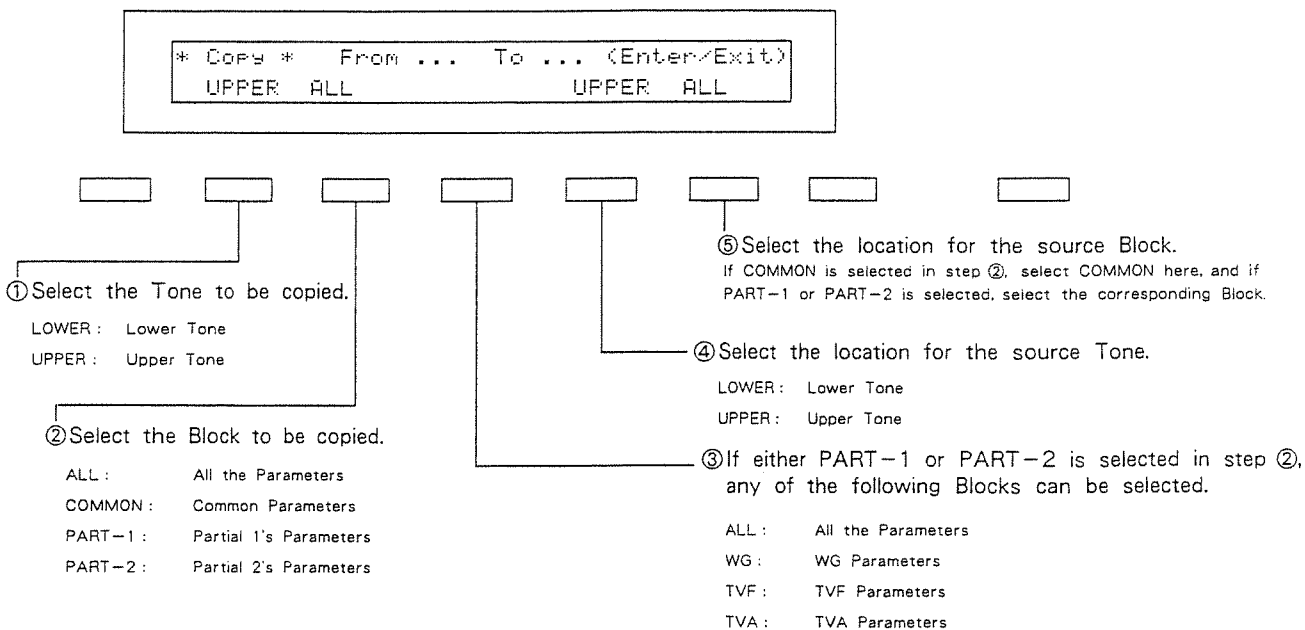

To cancel the copying mode, simply push the Exit Button.

- Step 3 Hit the Enter Key.

When the copy is completed, the Display responds as shown below, then returns to the Play Mode indication.

Complete .

*If you try to copy a Common parameter to a Partial parameter or vice versa, the Display will show the following error message and the copying cannot be done.

Data Mismatch
Cancel ...

d. Partial Mute

While editing a Partial parameter, any Partial sound can be muted. This function can be done in any Partial Display.

Simply push the Patch Button (1 to 4) that corresponds to the Partial to be muted.

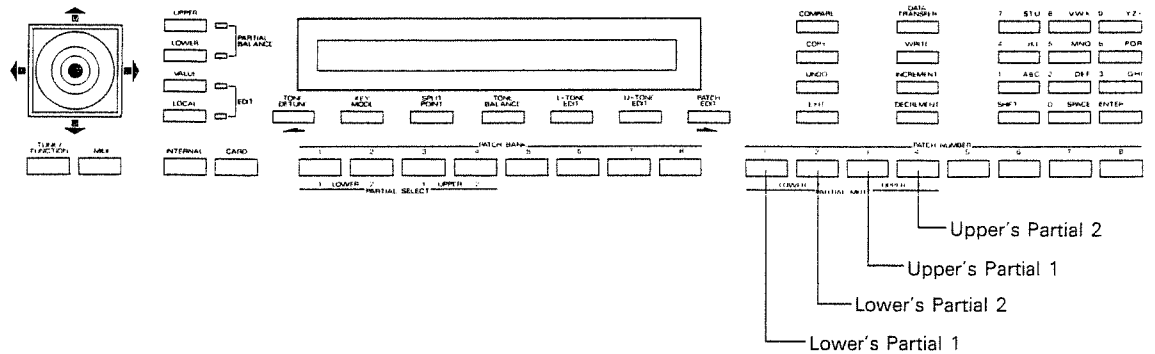

The mute status of all Partials is shown in any Partial Display.

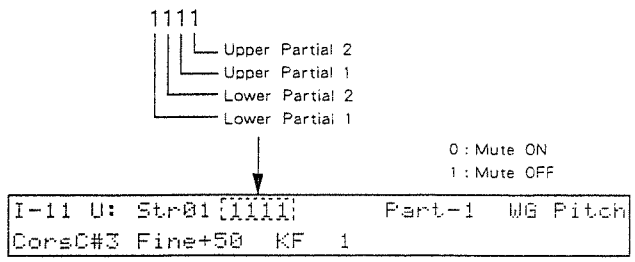

*The Partial Mute setting will be automatically written into memory by taking the Writing Procedure on page 48.

e. Partial Balance

The Partial Balance function can be obtained in any Edit Display or Play Mode Display.(Except for the Edit Display of the Patch Name and Tone Name.)

Step 1 Select either of the Tones with the Partial Balance Button.

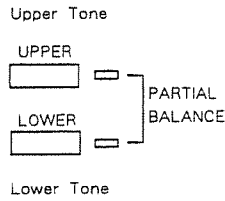

Step 2 **With the Joystick, set the volume balance you like.**

Upper volume increases and the
lower volume decreases.

Partial 1 Volume increases and
Partial 2 volume decreases.

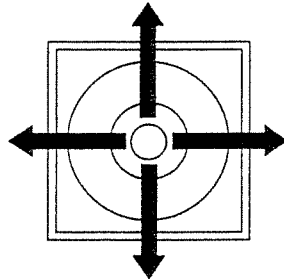

Partial 1 volume decreases and
Partial 2 volume increases.

Upper volume decreases and
Lower volume increases.

Step 3 **To return to the usual editing condition, select another parameter or change the Display.**

4. SOUND CREATION

There are two methods of sound creation.

- (1) Editing an existing sound.
- (2) Initializing all the parameters of a certain Partial and then editing the Partial.

How to initialize a Partial :

- Step 1** Call the Menu Display of the Partial to be initialized, then assign "* Init *" with the Selector Button.

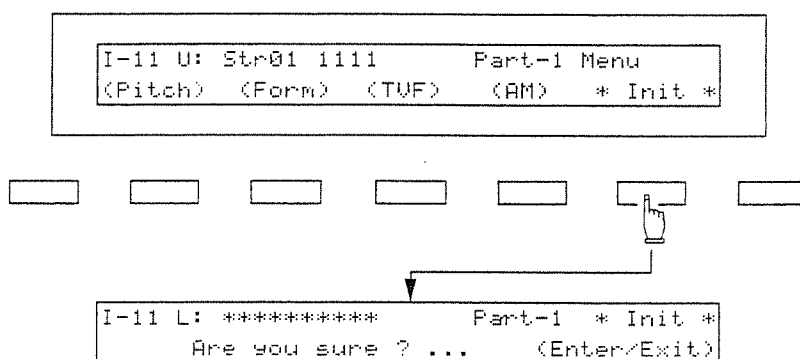

- Step 2** Push the Enter Key, and all the parameters of the selected Partial will be initialized, the Display will show as below for a few seconds.

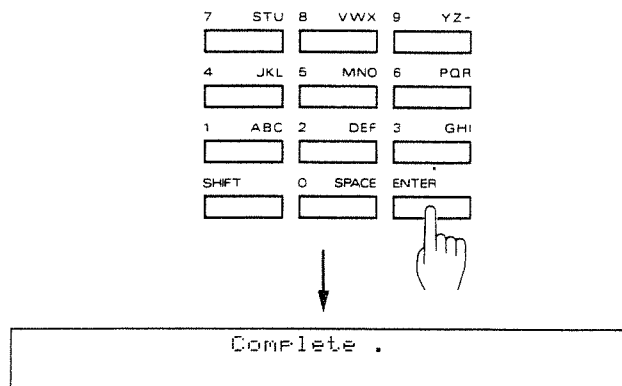

5. NAMING

Editing Patch or Tone names is called Naming in this manual.

- A Patch name can have up to 18 letters.
- A Tone name can have up to 10 letters.

Step 1 Call the Naming Display.

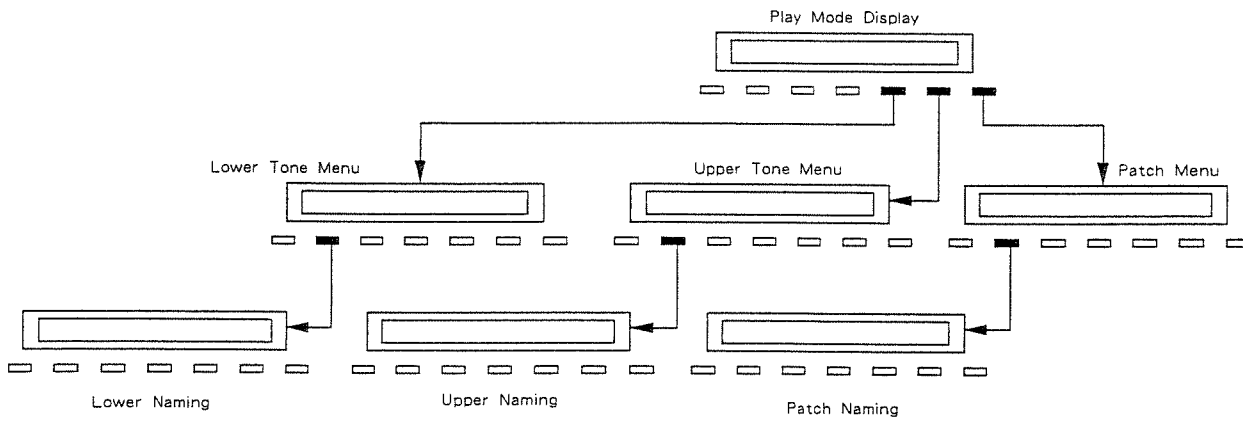

Step 2 Push the appropriate Selector Button to move to the letter you wish to change, and the letter flashes.

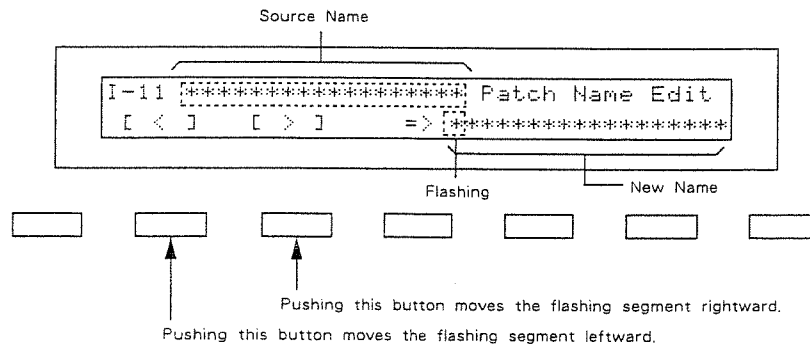

Step 3 Change the letters by either of the following methods.

[Using the Joystick/Increment Button, Decrement Button]

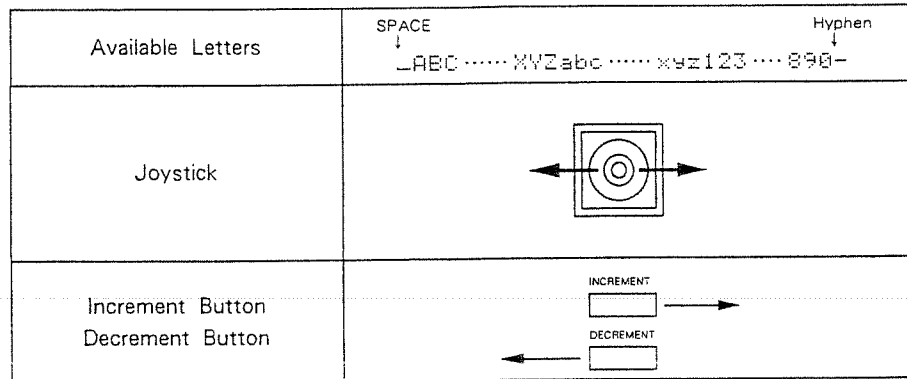

[Using the Ten Key Pad]

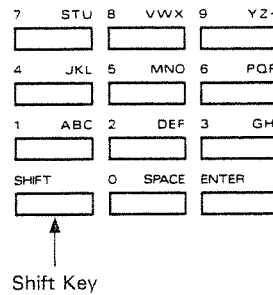

● Assigning a number

Push the key that is marked with the number you want once.

● Assigning a capital letter

Push the key that includes the letter you want several times, until the correct letter appears.

● Assigning a small letter

While holding the Shift Key down, push the the key that includes the letter you want, (as for capital letters.)

● Space/Hyphen

Push the 0 key twice for a space.
Push the 9 key four times for a hyphen.

Step 4 Repeat Steps 2 and 3 as many times as necessary.

3 TONE PARAMETERS

This section describes all about the Tone Parameters.

Each Display is numbered as shown in the Edit Map.

*The parameters which can be set with the Ten Key Pad have the 10 key marks as shown below.

10 key

1. COMMON PARAMETERS

a. Structure

[Display 16]

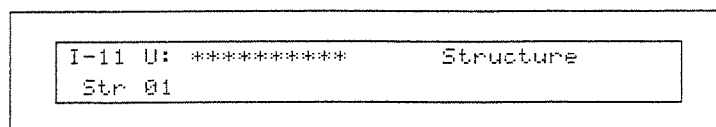

● Structure Number **10 key**

Select one of the following seven Structures.

S (Synthesizer Sound Generator)

P (PCM Sound Generator)

R (Ring Modulator)

Structure Number	Partial 1	Partial 2	Combination of two Partials	Block Diagram
1	S	S	Mixture of Partial 1 and Partial 2.	
2	S	S	Mixture of Partial 1 and ring-modulation.	
3	P	S	Mixture of Partial 1 and Partial 2.	
4	P	S	Mixture of Partial 1 and ring-modulation.	
5	S	P	Mixture of Partial 1 and ring-modulation.	
6	P	P	Mixture of Partial 1 and Partial 2.	
7	P	P	Mixture of Partial 1 and ring-modulation.	

b. P-ENV

[Display 17]

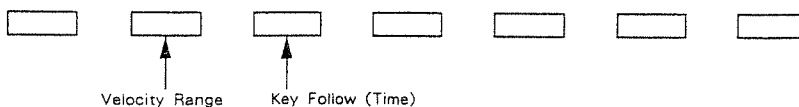
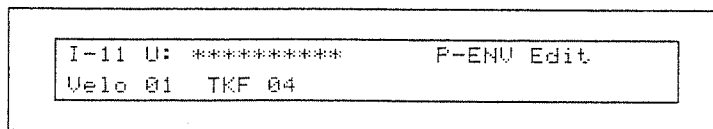

● **Velocity Range** **10 key**

This sets the maximum effect of the velocity that controls the pitch of the P-ENV. 0 to 2 are valid. At higher values, the keyboard velocity has a greater effect on the envelope.

● **Key Follow (Time)** **10 key**

This sets the time of the P-ENV depending on the key played 0 to 4 are valid. Higher values change the time more drastically.



[Display 18]

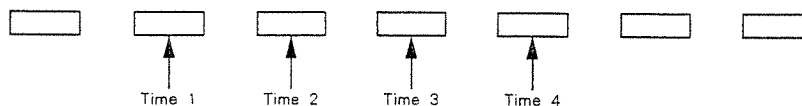
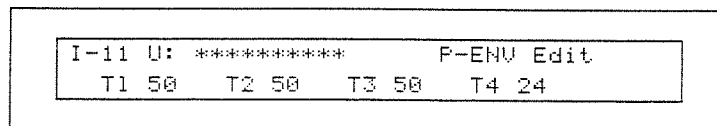

[Display 19]

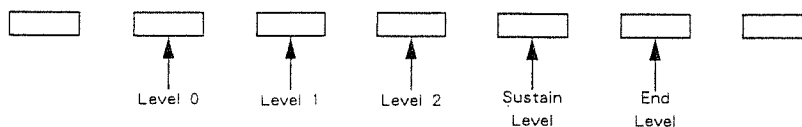
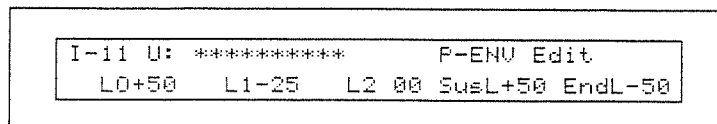

The envelope curve is determined by times and levels.

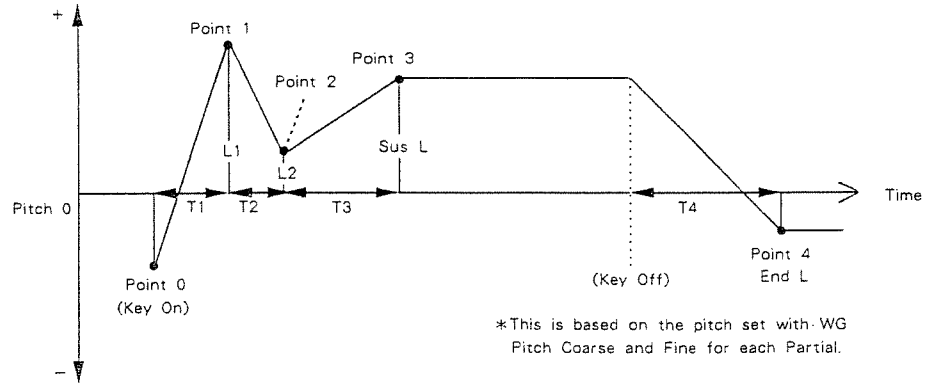

● **Time 1 10 key**

This sets the time needed from point 0 (the moment the key is pressed) to point 1. 0 to 50 are valid.

● **Level 0**

This sets the pitch created the moment a key is pressed from -50 to +50.

● **Time 2 10 key**

This sets the time needed from point 1 to point 2. 0 to 50 are valid.

● **Level 1**

This sets the pitch of the point 1 from -50 to +50.

● **Time 3 10 key**

This sets the time needed from point 2 to point 3. 0 to 50 are valid.

● **Level 2**

This sets the pitch of the point 2 from -50 to +50.

● **Sustain Level**

This sets the pitch of point 3 from -50 to +50.

● **Time 4 10 key**

This sets the time needed from the moment the key is released to point 4. 0 to 50 are valid.

● **End Level**

This sets the pitch of point 4 from -50 to +50.

*If the Levels of two adjacent points are set to similar values, the time between these two points may prove to be shorter than what is actually set, or even zero.

Velocity Range	Level	Range
0	+50	+1 octave
	-50	-1 octave
1	+50	+1.5 octave
	-50	-1.5 octave
2	+50	+2 octave
	-50	-2 octave

c. Pitch Modulation

[Display 20]

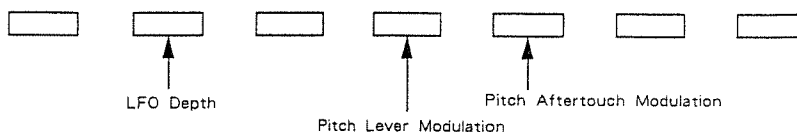
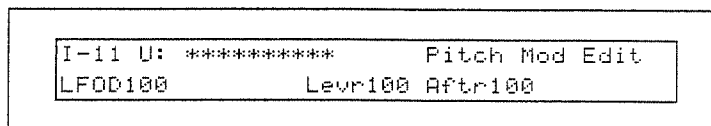

*Depending on how the LFO in WG modulation (Display 27) is set, the vibrato set here may have no effect at all. Higher values deepen the effect.

● LFO Depth **10 key**

This sets the depth of LFO-1, that controls the WG pitch. 0 to 100 are valid.

● Pitch Lever Modulation **10 key**

This sets the sensitivity of the vibrato depth controlled by the bender lever from 0 to 100. Higher values deepen the effect.

● Pitch Aftertouch Modulation **10 key**

This sets the sensitivity of the vibrato depth controlled by aftertouch from 0 to 100. Higher values deepen the vibrato effect.

d. LFO

[Display 21-23]

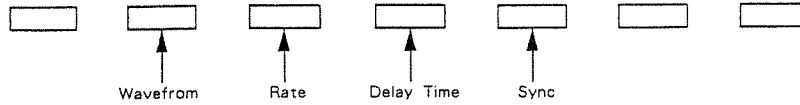
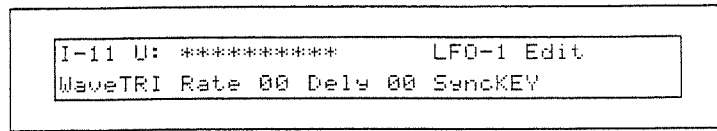

*The parameters of LFO-2 (Display 22) and LFO-3 (Display 23) can be set like LFO-1, except for a few parameters.

● **Waveform**

This selects the waveform of the LFO.

Display	Waveform
TRI (Triangle)	
SAW (Sawtooth)	
SQU (Square)	
RND (Random)	Waveform changes randomly.

● **Rate 10 key**

This sets the rate (frequency) of the LFO from 0 to 100. Higher values quicken the rate.

● **Delay Time 10 key**

This sets the time needed for the LFO to appear, from the moment a key is pressed. 0 to 100 are valid. Higher values increase the delay time.

● **Sync**

This selects the timing of the LFO oscillation as follows.

Display	Description
OFF	LFO does not sync to the keyboard.
ON	When a key is played after all keys have been released, the LFO begins its wave generating process from the beginning.
KEY	LFO begins its wave generation from the beginning each time a new key is played.

*For LFO-2 and LFO-3, "KEY" cannot be selected.

e. Equalizer

[Display 24]

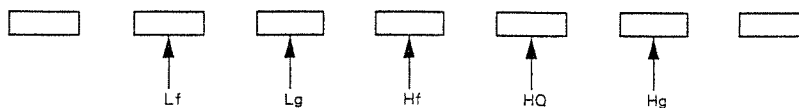
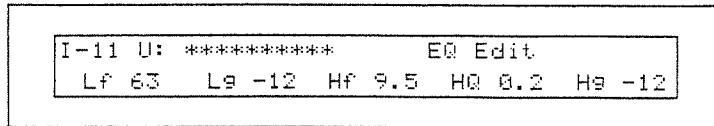

In the equalizer section, the frequency characteristic of the sound can be modified.

The Equalizer consists of the following parameters.

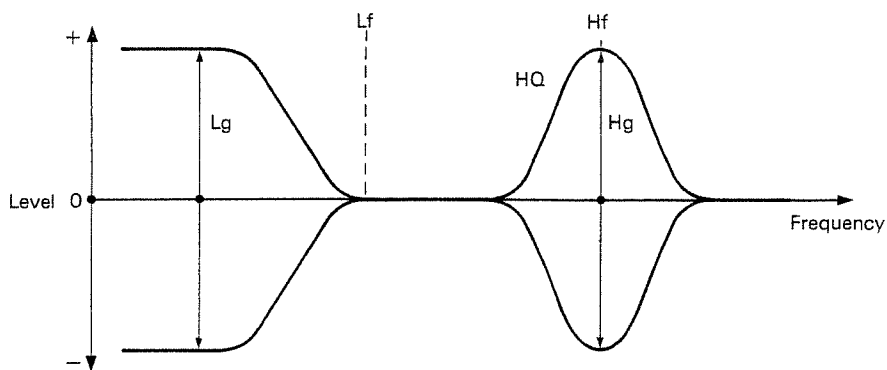

● Lf

This sets the frequency where the gain is altered in the low to middle range. 63Hz to 840Hz (16 points) are valid.

● Lg

This sets the gain of the lower Frequencies in 1dB steps, from -12 to +12dB (25 points). "+" settings raise the gain, and "-" settings lower it.

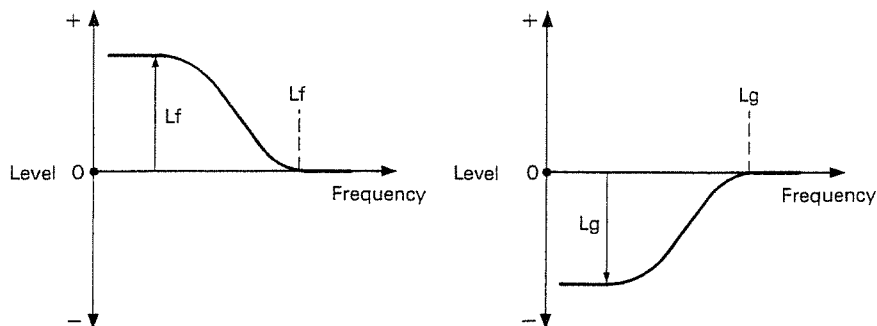

● **Hf**

This sets the frequency where the gain is altered in the middle to high range, from 250Hz to 9.5kHz (22 points).

● **HQ**

This sets the width of the frequency band where the gain is boosted or cut from 0.3 to 6.0 (9 points). With a higher value, the frequency band is narrower, and vice versa.

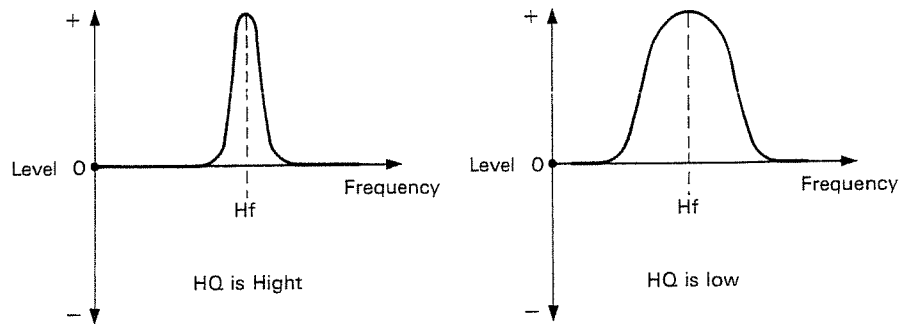

● **Hg**

This sets the gain of the Hf frequency from -12 to +12dB (in 1dB step, 25 points). "+" settings raise the gain and "-" settings lower it.

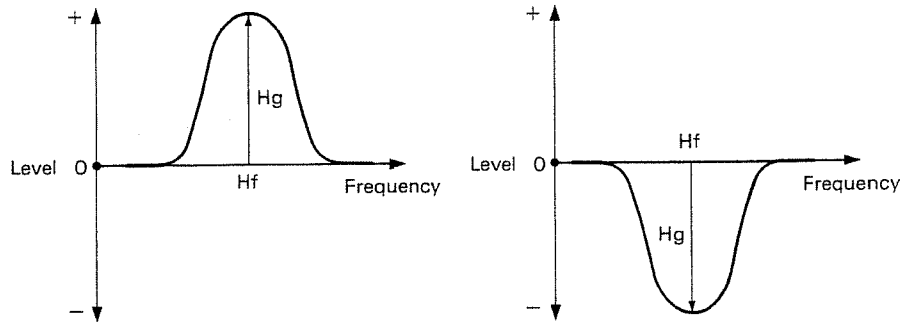

f. Chorus

[Display 25]

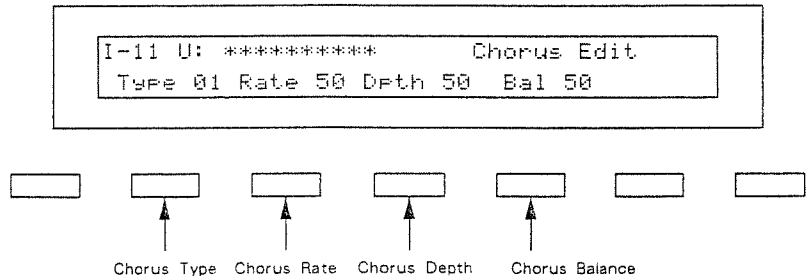
● Chorus Type **10 key**

This selects one of the 8 basic chorus effects.

1	Chorus 1
2	Chorus 2
3	Flanger 1
4	Flanger 2
5	Feedback Chorus
6	Tremolo
7	Chorus Tremolo
8	Dimension

● Chorus Rate **10 key**

This sets the rate of the chorus effect, from 0 to 100. Higher values quicken the rate.

● Chorus Depth **10 key**

This sets the depth of the chorus effect, from 0 to 100. Higher values deepen the effect.

● Chorus Balance **10 key**

This sets the volume balance of the chorus sound and normal sound, from 0 to 100.

100 Only the chorus sound is heard.
 }
 50 Chorus sound = Normal sound
 }
 0 Only the normal sound is heard.

2. PARTIAL PARAMETERS

[Restriction of the available parameters caused by Structure]

Depending on what Structure is used, the available parameters may be different. So, first check the Structure number shown in the Partial Display, then set the parameters.

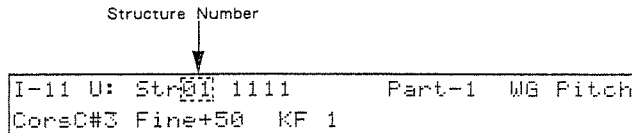

(1) In some Structures, some parameters included in a Partial that uses a PCM sound generator are invalid. The following mark is shown when the parameters apply even for PCM sounds.

PCM

(2) In some Structures which use Ring Modulation, some parameters in Partial 2 will automatically become the same as for Partial 1. Therefore, the values shown in the Display are irrelevant with the actual values. The following mark is shown for such parameters.

Ring ☒

a. WG Pitch

[Display 26]

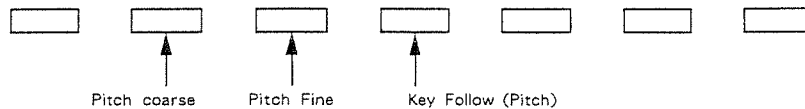
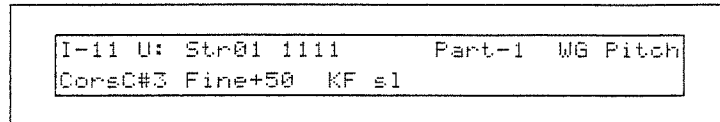

● Pitch Coarse **PCM**

This sets the standard pitch of a Partial in semi-tone steps from C1 to C7.

*The standard pitch is the pitch at C4 (middle C) key.

● Pitch Fine **PCM**

The standard pitch can be altered over about ± 50 cents from -50 to $+50$.

● Key Follow (Pitch) **PCM**

Usually, the keyboard of a synthesizer assigns a semi-tone to each key. This parameter can change the pitch ratio as shown below.

The value represents how many octaves are changed over 12 keys.

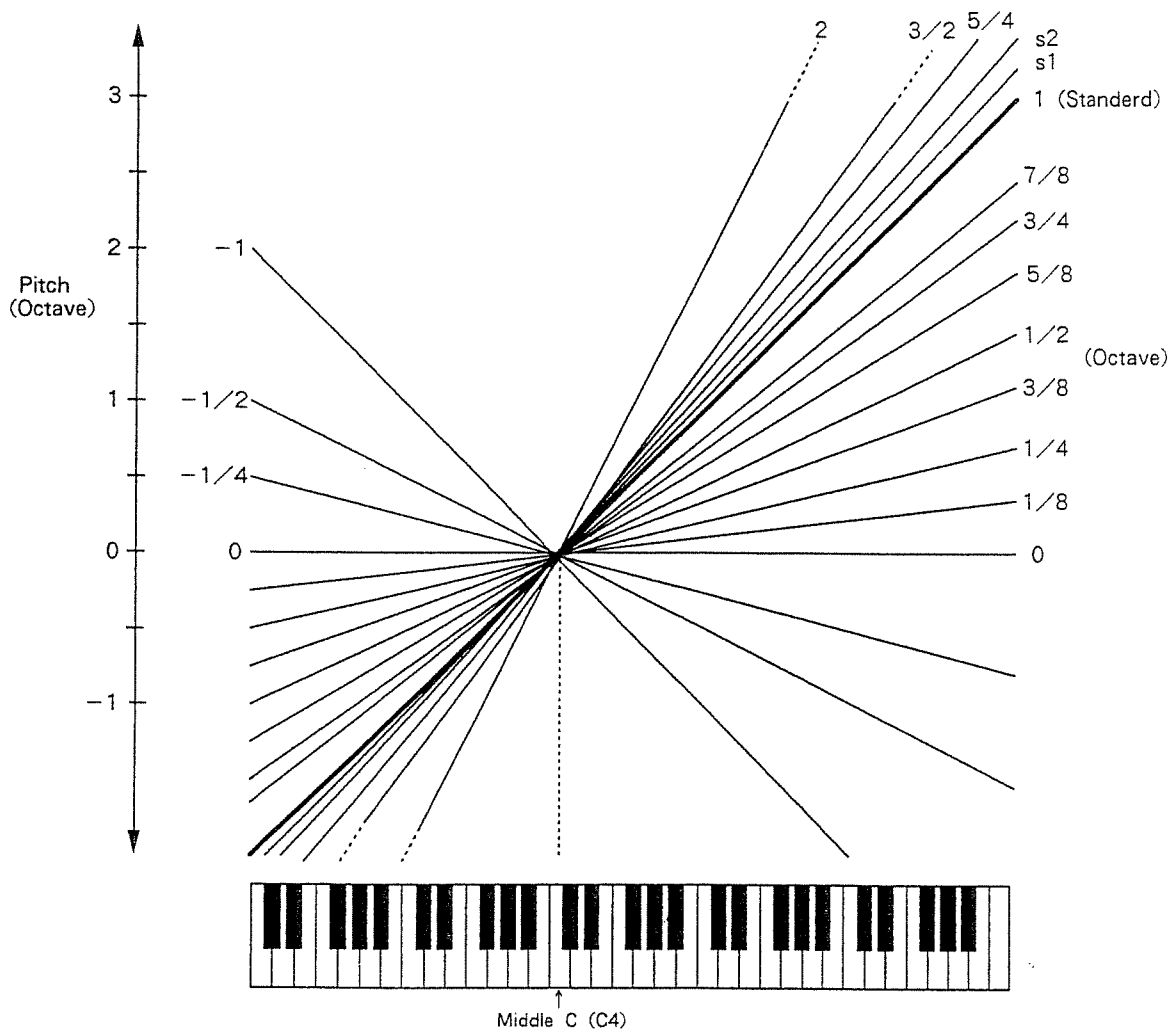

*s1 or s2 may be selected for slightly stretching octaves.

s1 : Pitch 1 cent higher than one octave.

s2 : Pitch 5 cents higher than one octave.

b. WG Modulation

[Display 27]

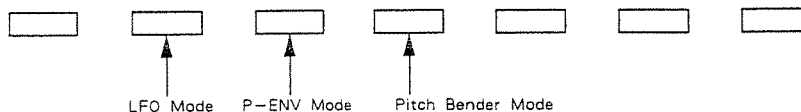
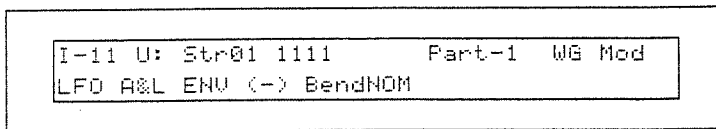

● LFO Mode **PCM**

This selects one of the following four vibrato modes.

Display	Description
OFF	No vibrato is obtained.
(+)	Vibrato is on.
(-)	Vibrato is on but inverted.
A&L	Vibrato can be obtained only by Aftertouch and Bender Lever.

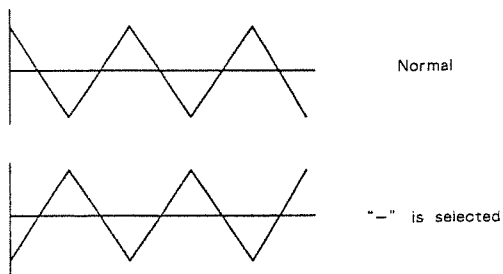

● P-ENV Mode **PCM**

This selects one of the following three modes, determining how the pitch is controlled by P-ENV.

Display	Description
OFF	No alteration.
(+)	Pitch changes with the set P-ENV curve.
(-)	Pitch changes with the P-ENV curve inverted.

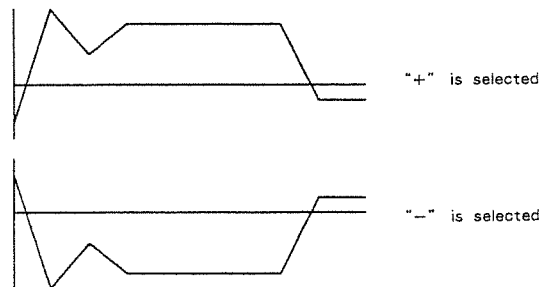

● **Bender Mode** **PCM**

This selects how the pitch is controlled by the bender lever as follows.

Display	Description
OFF	No pitch alteration by moving the Lever right or the left.
KEY	Pitch changes within the Bender range, set in Patch Factors, plus Key Follow (Pitch) of WG. (See the example shown right.)
NOM	Pitch changes within the Bender range, set in Patch Factors.

[Example]

If the Bender range is set to 12 (1 octave), and the Key Follow (Pitch) of WG is set to 2, the maximum pitch change caused by moving the Bender lever is 2 octaves. When the Key Follow (Pitch) of WG is set to zero, there is no pitch change caused by the Bender lever.

c. **WG Waveform**

[Display 28]

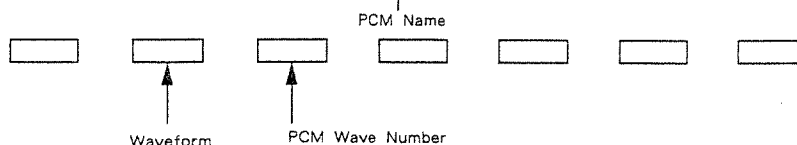
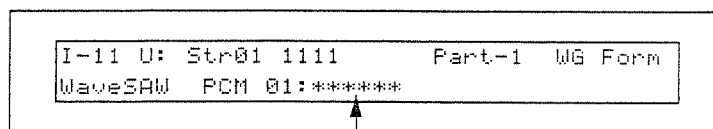

● **Waveform**

This selects the waveform of the synthesizer sound generator.

Display	Waveform
SQU (Square)	
SAW (Sawtooth)	

*A sawtooth waveform is produced by processing a square waveform at the TVF, that is, all the waveforms are square at WG even when a sawtooth is selected.

● **PCM Wave Number** **PCM** **10 key**

This selects one of the 100 different sampled waves of the PCM sound generator. Each sample is named (PCM name) as shown on the next page :

● TONE PARAMETERS

- 1~47 (One-Shot sounds are programmed.)
- 48~76 (Looped sounds are programmed.)
- 77~100 (Some of the sounds 1 to 76, are combined and looped.)

Number	Display	PCM Name	Number	Display	PCM Name
1	Marma	Marimba	51	EP_lp1	Electric Piano (Loop 1)
2	Vibes	Vibraphone	52	EP_lp2	Electric Piano (Loop 2)
3	Xylo1	Xylophone 1	53	CLAV1p	Clavi (Loop)
4	Xylo2	Xylophone 2	54	HC_lp	Harpsichord (Loop)
5	Log_Bs	Log Bass	55	EB_lp1	Electric Bass (Loop 1)
6	Hammer	Hammer	56	AB_lp	Acoustic Bass (Loop)
7	JpnDrm	Japanese Drum	57	EB_lp2	Electric Bass (Loop 2)
8	Kalimba	Kalimba	58	EB_lp3	Electric Bass (Loop 3)
9	Pluck1	Pluck 1	59	EG_lp	Electric Guitar (Loop)
10	Chink	Chink	60	CELLlp	Cello (Loop)
11	Agogo	Agogo	61	VIOLp	Violine (Loop)
12	3angle	Triangle	62	Reedlp	Leed (Loop)
13	Bells	Bell's	63	SAXlp1	Sax (Loop 1)
14	Nails	Nail File	64	SAXlp2	Sax (Loop 2)
15	Pick	Pick	65	Aah_lp	Aah (Loop)
16	Lpiano	Low Piano	66	Ooh lp	Ooh (Loop)
17	Mpiano	Mid Piano	67	Manlp1	Male (Loop 1)
18	Hpiano	High Piano	68	Spect1	Spectrum 1 (Loop)
19	Harpsi	Harpsichord	69	Spect2	Spectrum 2 (Loop)
20	Harp	Harp	70	Spect3	Spectrum 3 (Loop)
21	OrgPrc	Organ Percussion	71	Spect4	Spectrum 4 (Loop)
22	Steel	Steel Strings	72	Spect5	Spectrum 5 (Loop)
23	Nylon	Nylon Strings	73	Spect6	Spectrum 6 (Loop)
24	Eguit1	Electric Guitier 1	74	Spect7	Spectrum 7 (Loop)
25	Eguit2	Electric Guitar 2	75	Manlp2	Male (Loop 2)
26	Dirt	Dirty Guitar	76	Noise	Noise (Loop)
27	P_Bass	Pick Bass	77	Loop01	
28	Pop	Pop Bass	78	Loop02	
29	Thump	Thump	79	Loop03	
30	Uprite	Upright Bass	80	Loop04	
31	Clarnt	Clarinet	81	Loop05	
32	Breath	Breath	82	Loop06	
33	Steam	Steamer	83	Loop07	
34	FluteH	High Flute	84	Loop08	
35	FluteL	Low Flute	85	Loop09	
36	Guiro	Guiro	86	Loop10	
37	IndFlt	Indian Flute	87	Loop11	
38	Harmo	Flute Harmonics	88	Loop12	
39	Lips1	Lips 1	89	Loop13	
40	Lips2	Lips 2	90	Loop14	
41	Trumpt	Trumpet	91	Loop15	
42	Bones	Trombones	92	Loop16	
43	Contra	Contrabass	93	Loop17	
44	Cello	Cello	94	Loop18	
45	VioBow	Violin Bow	95	Loop19	
46	Violns	Violins	96	Loop20	
47	Pizz	Pizzicart	97	Loop21	
48	Drawbr	Draw bars (Loop)	98	Loop22	
49	Horgan	High Organ (Loop)	99	Loop23	
50	Lorgan	Low Organ (Loop)	100	Loop24	

d. WG Pulse Width

[Display 29]

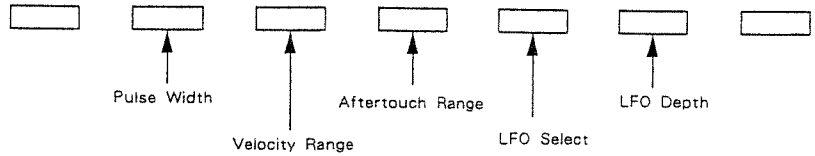
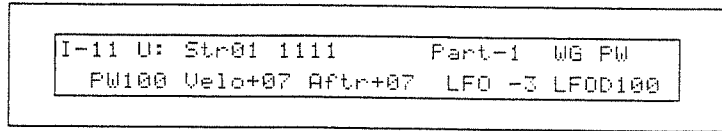

● Pulse Width **10 key**

A square waveform has exactly the same width, up and down but a Pulse Width waveform has different widths. The ratio of upper width to lower is called pulse width, 0 to 100 are valid for setting the pulse width. Depending on the set pulse width value, the harmonic content of the sound changes greatly.

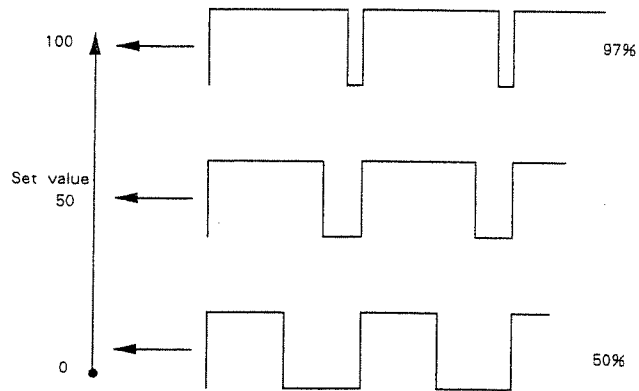

*When a sawtooth is selected with WG Waveform, pulse width 50% raises the pitch by an octave.

● Velocity Range

This sets the sensitivity of the velocity that controls the pulse width from -7 to +7. With "-" values, the pulse width becomes smaller by playing the keyboard harder, and with "+" values, the pulse width becomes wider by playing the keyboard harder.

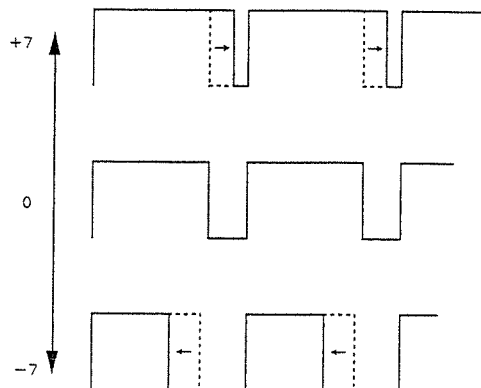

● **Aftertouch Range** **Ring**

This sets the sensitivity of the aftertouch that controls the pulse width from -7 to +7. With "-" values, the pulse width becomes smaller with stronger aftertouch, and with "+" values, the pulse width becomes wider with stronger aftertouch.

● **LFO Select** **Ring**

Pulse Width Modulation (PWM) means changing the pulse width periodically. LFO Select decides which of the LFO's is to be used for modulating the pulse width.

Display	LFO (Phase)
+1	LFO-1 (+)
-1	LFO-1 (-)
+2	LFO-2 (+)
-2	LFO-2 (-)
+3	LFO-3 (+)
-3	LFO-3 (-)

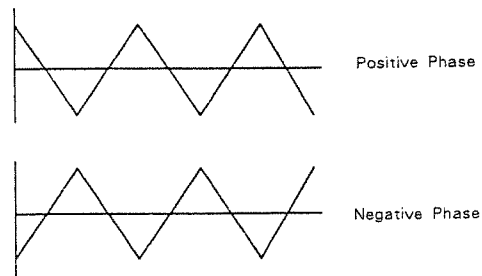

● **LFO Depth** **Ring** **10 key**

This sets the depth of the PWM from 0 to 100. Higher values deepen the effect.

e. TVF

[Display 30]

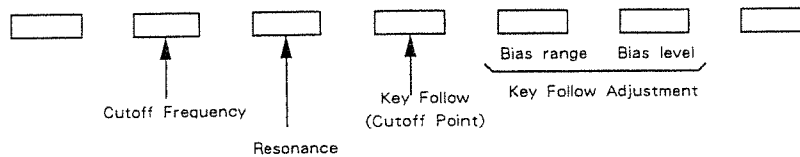
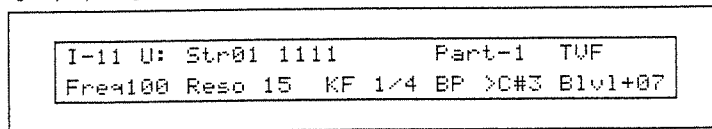

● **Cutoff Frequency** **10 key**

This sets the cutoff point of the TVF from 0 to 100. As you lower the value, higher frequencies are removed and the waveform gradually become an approximation of a sine wave, then the sound will finally fade out.

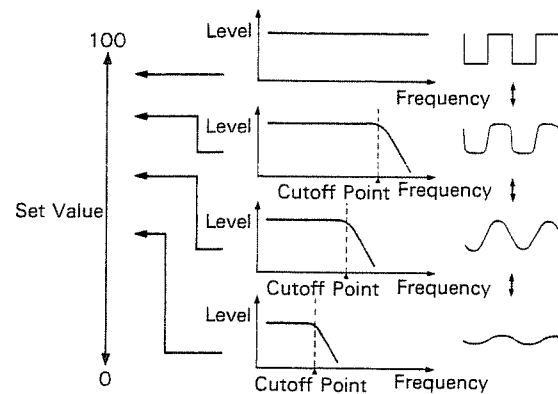

● **Resonance** **10 key**

This boosts the cutoff point from 0 to 30. As you increase the value, specific harmonics are emphasized and the sound will become more unusual, more electronic in nature.

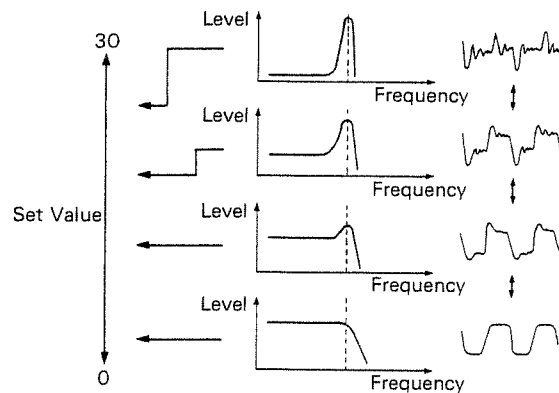

● **Key Follow (Cutoff Point)**

Key Follow can change the cutoff point depending on the key played.

Just like the Key follow of WG pitch, the value represents how many octaves change over 12 keys.

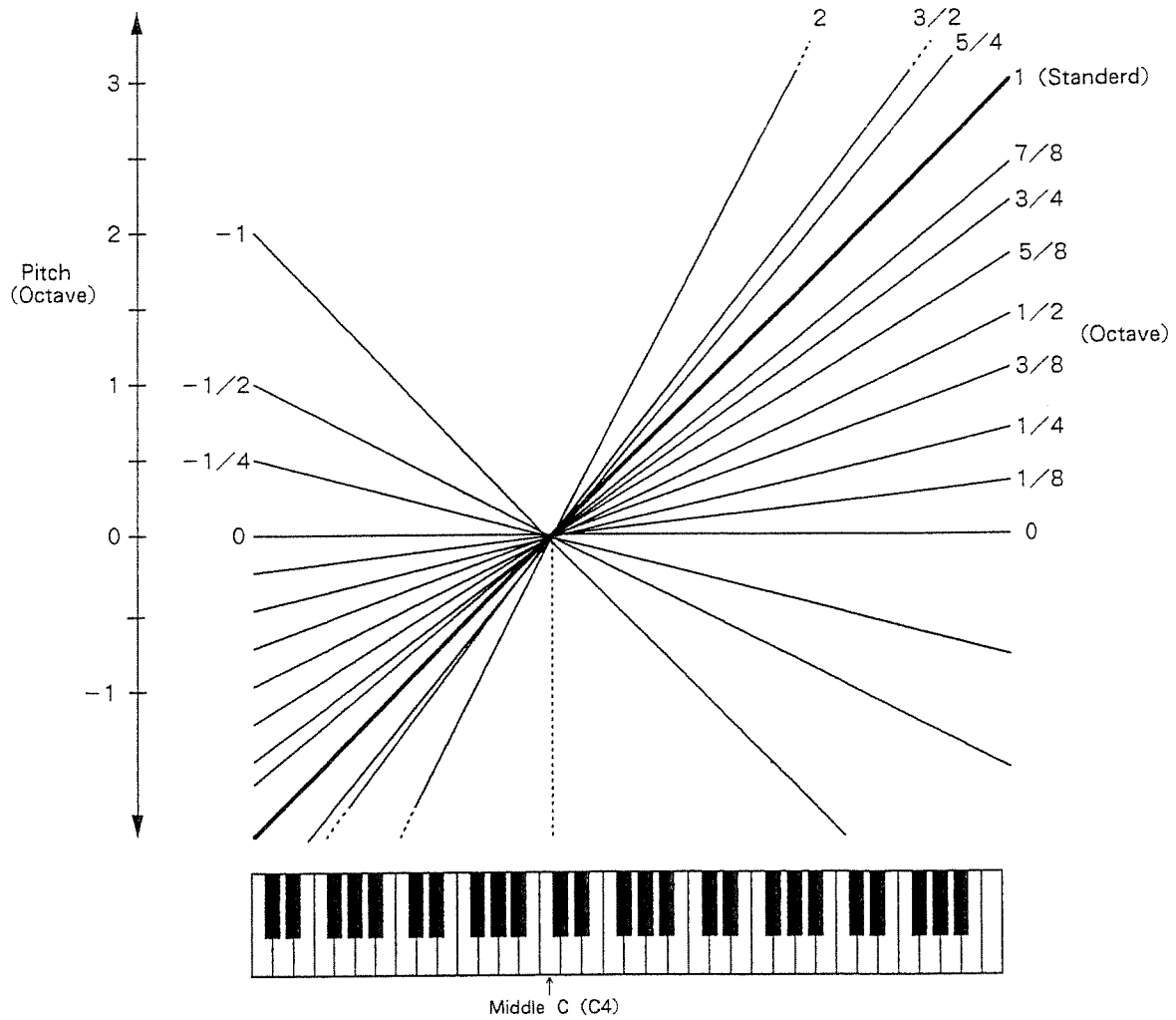

[Key Follow Adjustment]

You can add a further change (=bias level) to the Key Follow curve, and set the range (bias range) where the bias level is valid.

- The bias range is where the bias level is valid on the keyboard. It can be set with the bias point (where the bias range begins) and bias direction (< or >) from <A1 to <C7 and from >A1 to >C7 in semi-tone steps.

[e.g.]

>C4 : The bias level is only valid on the keyboard above the C4 key.

<C4 : The bias level is only valid on the keyboard below the C4 key.

- The bias level can be set from -7 to +7. "+" values raise the curve, and "-" value lower the curve.

[Example]

When set to TVF Key Follow (Cutoff Point) "0" and Bias range ">C4"

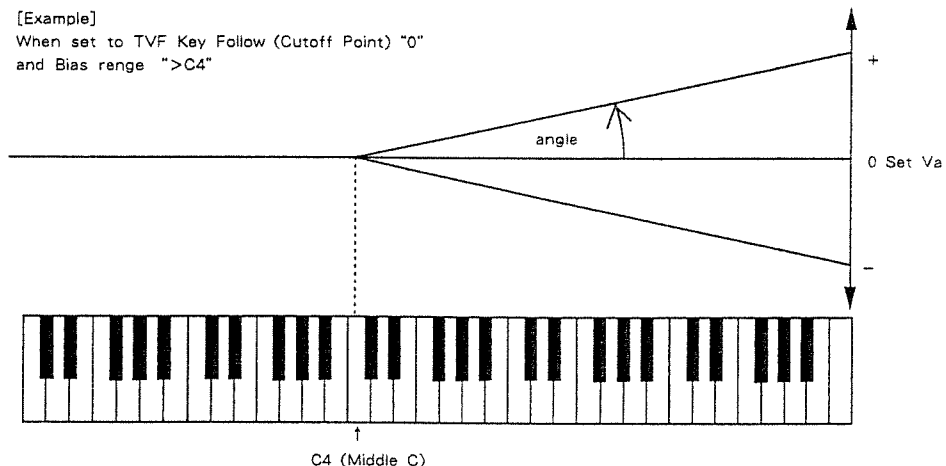

*The curve in the picture represents the Key Follow value with the bias level added.

f. TVF ENV

[Display 31]

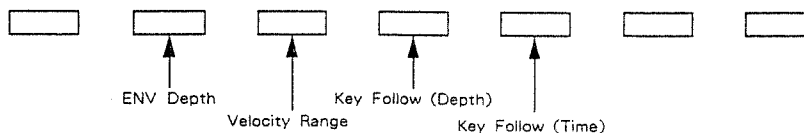
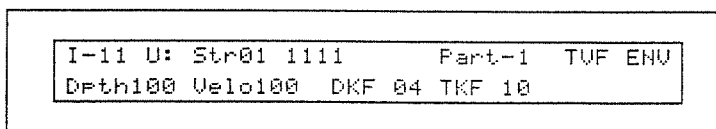

● ENV Depth **10 key**

This sets the depth of the TVF ENV modulation that changes the TVF Cutoff Point. 0 to 100 are valid. Higher values deepen the effect.

● Velocity Range **10 key**

This sets the sensitivity of the velocity that controls the depth of the TVF ENV. 0 to 100 are valid. At higher values, the effect is deeper by playing harder.

● Key Follow (Depth) **10 key**

This can change the TVF ENV depth depending on the key played. 0 to 4 are valid, higher values change the depth more drastically.

● Key Follow (Time) **10 key**

This can change the time of the TVF ENV depending on the key played. 0 to 4 are valid, higher values change the time more drastically.

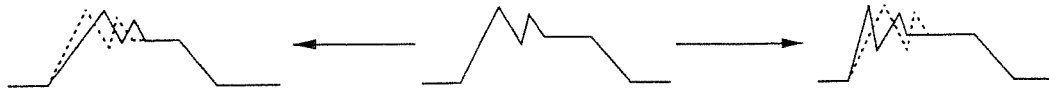
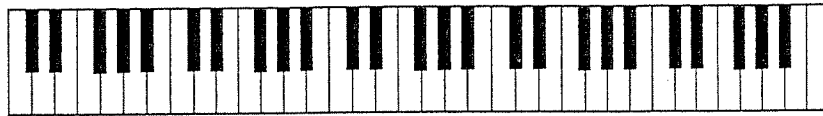

[Display 32]

```

I-11 U: Str01 1111      Part-1 TVF ENV
T1100  T2100  T3100  T4100  T5100
    
```

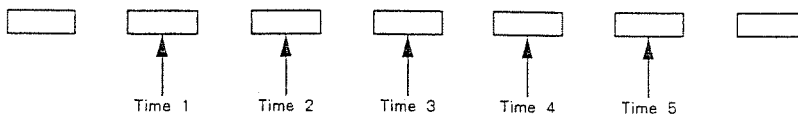

[Display 33]

```

I-11 U: Str01 1111      Part-1 TVF ENV
L1100  L2100  L3100  SusL100  EndL100
    
```

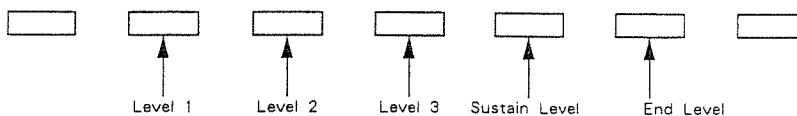

An envelope curve is determined by times and levels.

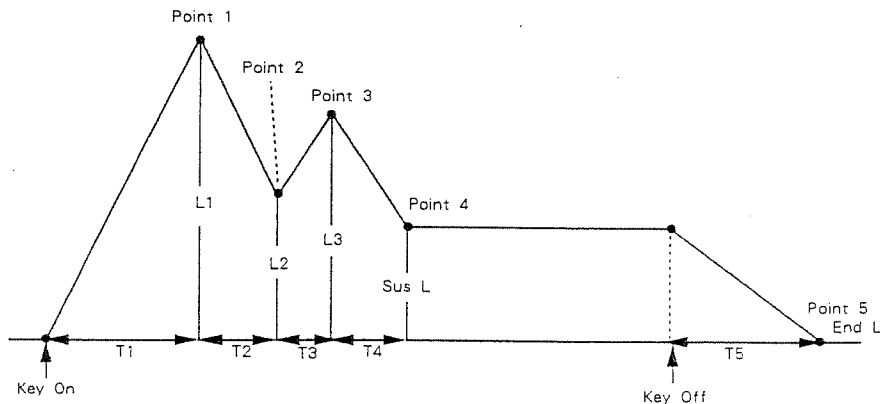

- **Time 1 10 key**
This sets the time needed to reach point 1 from the moment the key is pressed. 0 to 100 are valid.
- **Level 1 10 key**
This sets the level of point 1 from 0 to 100.
- **Time 2 10 key**
This sets the time needed to reach point 2 from point 1. 0 to 100 are valid.

● Level 2 **10 key**

This sets the level of point 2 from 0 to 100.

● Time 3 **10 key**

This sets the time needed to reach point 3 from point 2. 0 to 100 are valid.

● Level 3 **10 key**

This sets the level of point 3 from 0 to 100.

● Time 4 **10 key**

This sets the time needed to reach point 4 from point 3. 0 to 100 are valid.

● Sustain Level **10 key**

This sets the level of point 4 from 0 to 100.

● Time 5 **10 key**

This sets the time needed to reach point 5 from the moment the key is released. 0 to 100 are valid.

● End Level

To lower the level after releasing the key, set this to 0, and to raise the level, set it to 100.

*The End Level is retained until you release and play the key again.

*If the Levels of two adjacent points are set to similar values, the time between these two points may prove to be shorter than what is actually set, or even zero.

g. TVF Modulation

[Display 34]

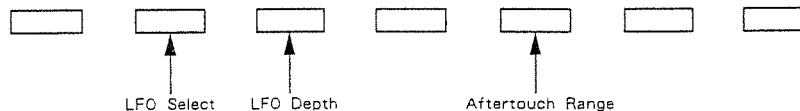
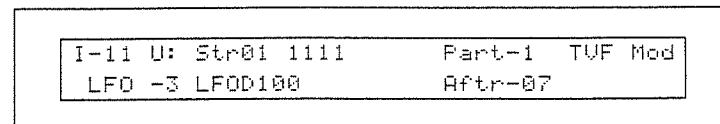

● LFO Select **Ring**

This selects the LFO that changes the cutoff point periodically (creating growl effects).

Display	LFO (Phase)
+1	LFO-1 (+)
-1	LFO-1 (-)
+2	LFO-2 (+)
-2	LFO-2 (-)
+3	LFO-3 (+)
-3	LFO-3 (-)

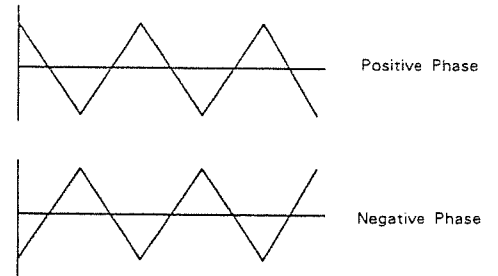

● LFO Depth **Ring** **10 key**

This sets the depth of a growl effect from 0 to 100. Higher values deepen the effect.

● Aftertouch Range **Ring**

This sets the sensitivity of the aftertouch that controls the cutoff point from -7 to +7. "-" values lower the cutoff point by stronger Aftertouch, and "+" values raise it.

h. TVA

[Display 35]

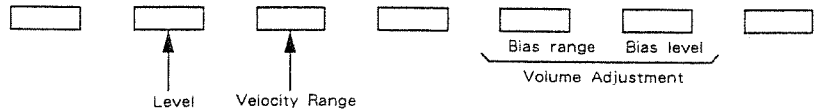
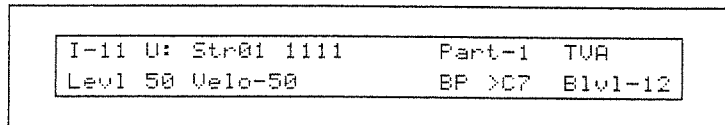

● Level **PCM** **10 key**

This sets the volume of a Partial from 0 to 100.

*Higher values may cause sound distortion. If so, lower the value.

*Even when the Level is set to zero here, the sound may not be completely muted if the TVA ENV curve is high.

● Velocity Rnage **PCM**

This sets the sensitivity of the velocity that controls the volume of the sound. -50 to +50 are valid. "-" values lower the level by harder playing, and "+" values raise the level by harder playing.

[Volume Adjustment] **PCM**

You can change the overall volume of the keyboard (=bias level) from the set level, and set the range (bias range) where the bias level is valid.

- The bias range is where the bias level is valid on the keyboard. It can be set with the bias point (where the bias range begins) and bias direction (< or >) from <A1 to <C7 and from >A1 to >C7 in semi-tone steps.

[e.g.]

- >C4 : The bias level is only valid on the keyboard above the C4 key.
- <C4 : The bias level is only valid on the keyboard below the C4 key.

- The curve (bias level) can be set from -12 to +0. Lower values make the curve steeper.

[Example]

When set to <C6.

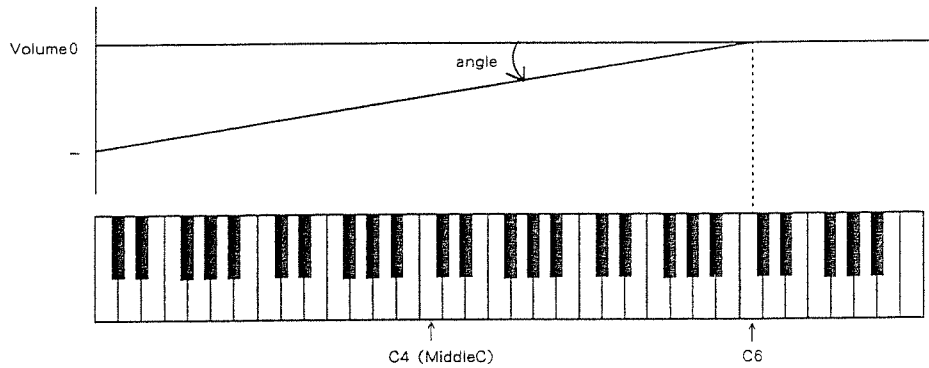

i. TVA ENV

[Display 36]

```
I-11 U: Str01 1111      Part-1 TVA ENV
      T1100  T2100  T3100  T4100  T5100
```

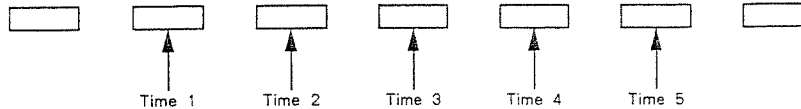

[Display 37]

```
I-11 U: Str01 1111      Part-1 TVA ENV
      L1100  L2100  L3100  SusL100  EndL100
```

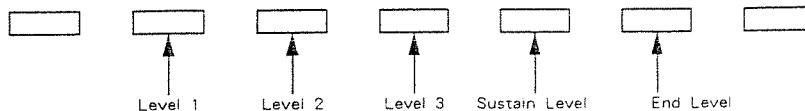

An envelope curve is determined by times and levels.

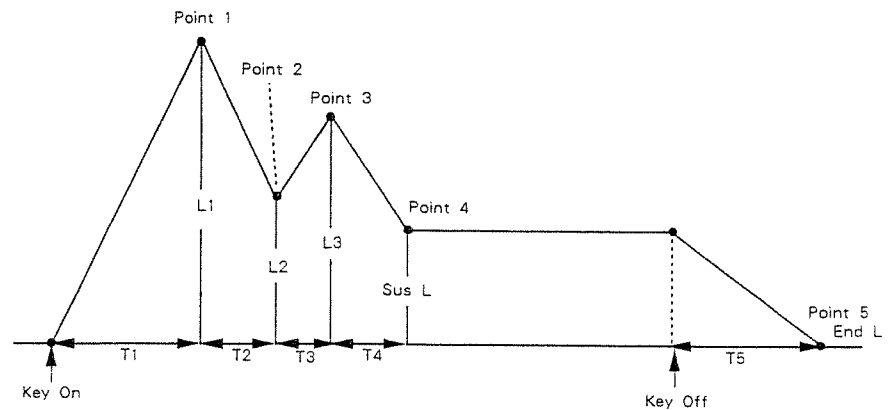

- **Time 1 PCM 10 key**
This sets the time needed to reach point 1 from the moment the key is pressed. 0 to 100 are valid.
- **Level 1 PCM 10 key**
This sets the level of point 1 from 0 to 100.
- **Time 2 PCM 10 key**
This sets the time needed to reach point 2 from point 1. 0 to 100 are valid.
- **Level 2 PCM 10 key**
This sets the level of point 2 from 0 to 100.
- **Time 3 PCM 10 key**
This sets the time needed to reach point 3 from point 2. 0 to 100 are valid.
- **Level 3 PCM 10 key**
This sets the level of point 3 from 0 to 100.
- **Time 4 PCM 10 key**
This sets the time needed to reach point 4 from point 3. 0 to 100 are valid.

● Sustain Level **PCM 10 key**

This sets the level of point 4 from 0 to 100.

● Time 5 **PCM 10 key**

This sets the time needed to reach point 5 from the moment the key is released. 0 to 100 are valid.

● End Level **PCM**

To lower the level after releasing the key, set this to 0, and to raise the level, set it to 100. The End Level remains until the key is released and played again. That is, at a value of 100, the sound remains. However, the PCM Sound Generator's One-shot sounds do not remain even when set to 100.

*If the Levels of two adjacent points are set to similar values, the time between these two points may prove to be shorter than what is actually set, or even zero.

[Display 38]

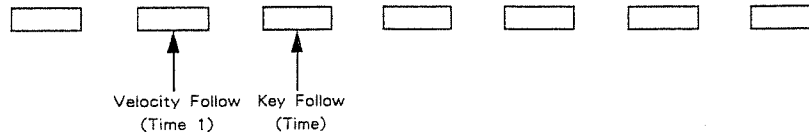
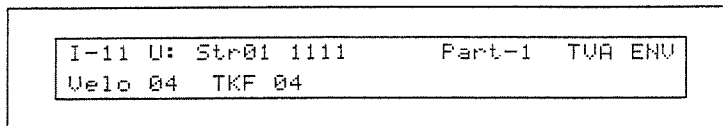

● Velocity Follow (Time 1) **PCM 10 key**

This sets the sensitivity of the velocity that controls the "Time 1" of the TVA ENV from 0 to 4. Increasing the sensitivity shortens "Time 1", by stronger playing.

● Key Follow (Time) **PCM 10 key**

This can change the time of the TVA ENV depending on the key played. 0 to 4 are valid. Higher values change the time more drastically.

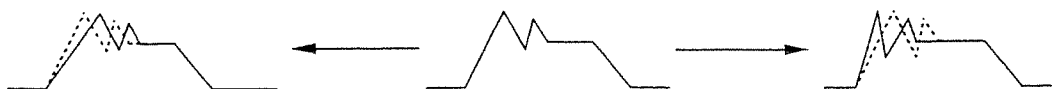

j. TVA Modulation

[Display 39]

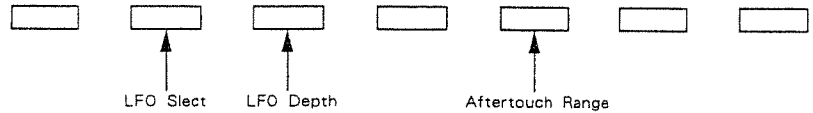
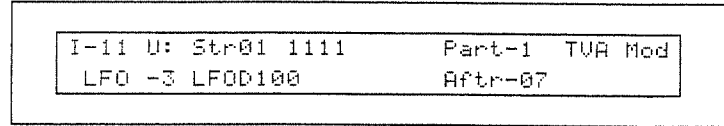

● **LFO Select** **Ring**

This selects the LFO that changes the volume periodically (tremolo effects).

Display	LFO (Phase)
+1	LFO-1 (+)
-1	LFO-1 (-)
+2	LFO-2 (+)
-2	LFO-2 (-)
+3	LFO-3 (+)
-3	LFO-3 (-)

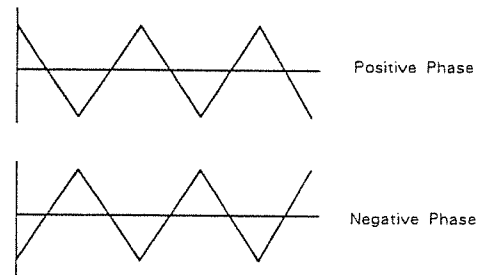

● **LFO Depth** **Ring** **10 key**

This sets the depth of the tremolo effect from 0 to 100. Higher values deepen the effect.

● **Aftertouch Range** **Ring**

This sets the sensitivity of the aftertouch that controls the volume from -7 to +7. "-" values lower the volume by stronger aftertouch, and "+" values increase the volume by stronger aftertouch.

4 WRITING

The edited data does not automatically rewrite the previous data, and therefore will be erased when a different Patch is selected, or the unit is turned off. To retain the edited data, take the following writing procedure, either into the internal memory or onto a Memory Card.

*When using a Memory Card (RAM) for the first time, be sure to write the data in the internal memory onto the Memory Card as shown in "Patch Transfer to the Memory Card" on page 65. If you take the writing procedure without doing this, the Display shows "Illegal Card" for a few seconds and writing is not done. This "Illegal Card" message is also shown when you are using a Memory Card that contains the data other than D-50's.

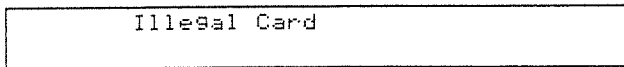

[SELECTING A MEMORY LOCATION]

Writing a new Patch inevitably erases an existing Patch, so you may wish to listen to several Patches before deciding which Patch should be sacrificed for the new Patch. You can do it using the Compare Button.

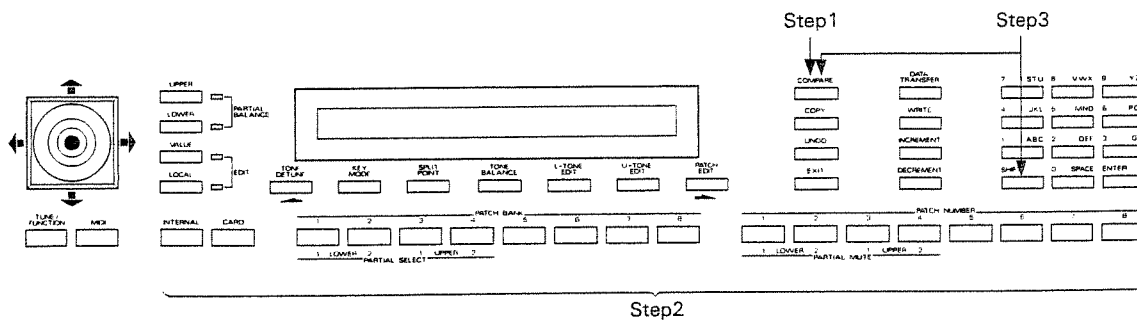

Step 1 Push the Compare Button.

The Display responds as shown below.

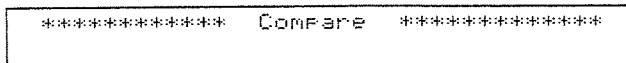

Step 2 As you change Patches, listen to the sound, selecting the Patch Number to be erased.

Step 3 WHILE HOLDING THE SHIFT KEY DOWN, push the Compare Button. This recalls the edited data at the selected Patch Number.

[WRITING PROCEDURE]

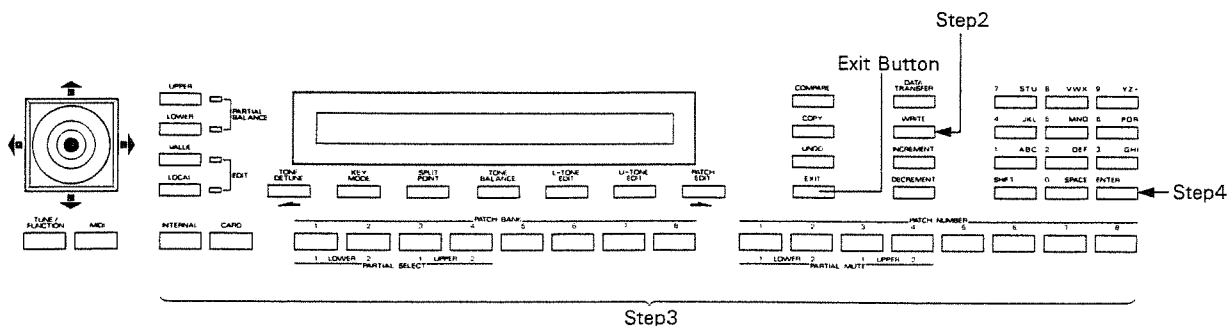

Step 1 Set Memory Protect to OFF.

● To write the data into the internal memory, set the Memory Protect of the D-50 to OFF as follows.

1: Push the Tune/Function Button.

2: Select "Memory Protect" with the Selector Button and turn it OFF with the Joystick.



This flashes when the Selector Button is pushed.

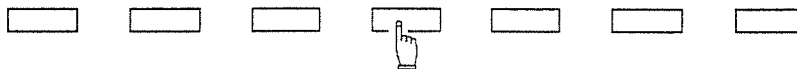
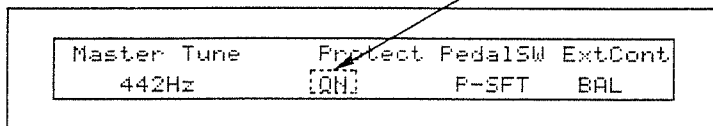

● To write the data onto the optional Memory Card (M-256D), set the Protect Switch of the Memory Card to OFF as follows.

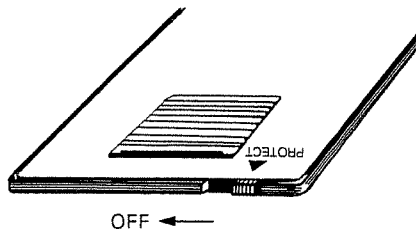

Step 2 Push the Write Button.

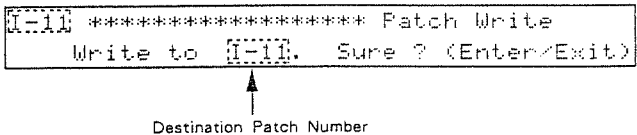

Step 3 If you wish to rewrite the Patch, skip the following two procedures and go to step 4, but if you wish to write the edited Patch to a different Patch number, change the destination Patch number as follows.

- To write the Patch into the internal memory of the D-50, push the Internal Button, and to write onto the Memory Card, push the Card Button.
- Assign the Bank and Number of the destination Patch by using the Patch Button.

To leave the writing mode, simply push the Exit Button.

Step 4 Push the Enter Key.

When the writing is completed, the Display responds as shown below, and then returns to Play mode.

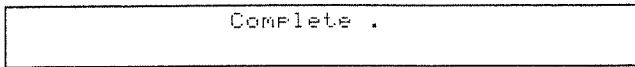

*If the Display does not respond as above, see "Error Messages" on page 74 , and repeat the writing procedure carefully.

Step 5 Return the Memory Protect to ON.
(As in Step 1.)

*Memory Protect is the function that protects the existing data from accidental erasure. Be sure to set the Memory Protect ON except when writing new data.

*When the unit is turned off and on again, the Memory Protect is automatically returned to the ON position.

5 MIDI

Please Read the separate booklet "MIDI" as well as the following explanation on MIDI.

1. CONNECTION

- The D-50 controlling an external MIDI device.

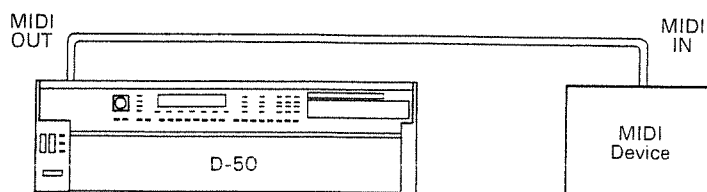

- An external MIDI device controlling the D-50

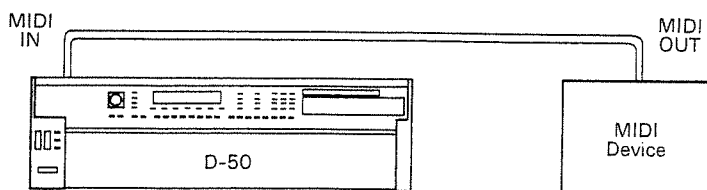

- Using the MIDI THRU Connector

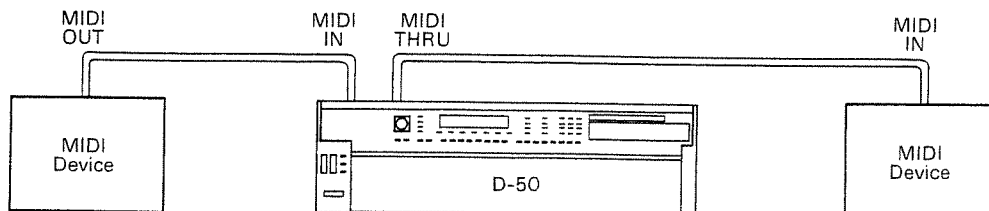

*An exact copy of the signal fed into the MIDI IN is sent through the MIDI THRU. Using the MIDI THRU, therefore, more than one MIDI device can be controlled. Technically speaking, many devices can be controlled through MIDI THRU's, but in practice, connecting more than a few devices would cause various complications. To connect several devices, use the optional MIDI Output Selector MPU-105.

*The signal fed into the MIDI IN is not sent from the MIDI OUT.

● **Control**

This determines how to receive messages from an external MIDI device.

[**B.CH**] **Basic Channel mode**

When the D-50 is being controlled in Mono mode, it receives the Voice Messages (except for Note Event, Pitch Bender) on the Basic Channel from the external device.

[**G.CH**] **Global Channel mode**

When the D-50 is being controlled in Mono mode, by an external device that has a Global Channel (one number smaller than the basic channel) it can receive all the Voice Messages (except for Note Event, Pitch Bender) on the Global Channel.

[**MdeOFF**] **Mode Message OFF mode**

In this mode, the D-50 does not receive the Mode messages from the external MIDI device, but is assigned to the Key mode as set on the D-50.

*How the above Control mode actually changes the Key mode set on the D-50 is explained on page 57 "Key Mode Alteration".

● **Receive Channel in Mono Mode**

When Separate (Solo) mode is selected (see page 21 in the Basic Course), the Upper and Lower Tones can be controlled on different channels. The Lower Tone is controlled by the basic channel, and the Upper Tone is controlled by the receive channel set here. (The D-50's keyboard can control only the Upper Tone.) 1 to 16 are valid for receive channel. The receive channel of each Patch can be set to a different number from the channel set here. (See page 56)

● **OMNI**

OMNI ON allows you to control the D-50 regardless of the MIDI channel of the external MIDI device.

● **Local**

Local OFF separates the keyboard section from the synthesizer section in the D-50. Therefore, Performance information is sent from the MIDI OUT, but the D-50 does not make any sound. The Performance information fed into the MIDI IN, however, can control the D-50's synthesizer section.

[MIDI-2]

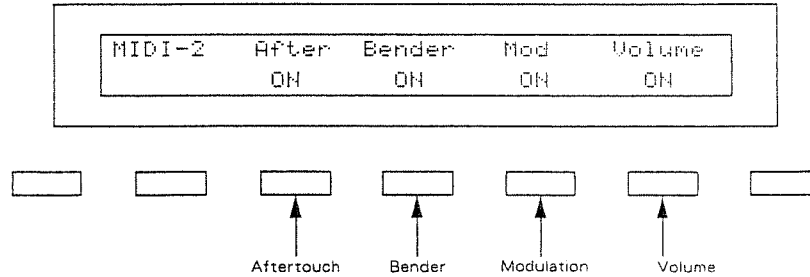
● **Aftertouch**

To receive or transmit Aftertouch messages, set this to ON.

● **Bender**

To receive or transmit Bender messages, set this to ON.

● **Modulation**

To receive or transmit Modulation messages, set this to ON.

● **Volume**

To receive or transmit Volume messages, set this to ON.

[MIDI-3]

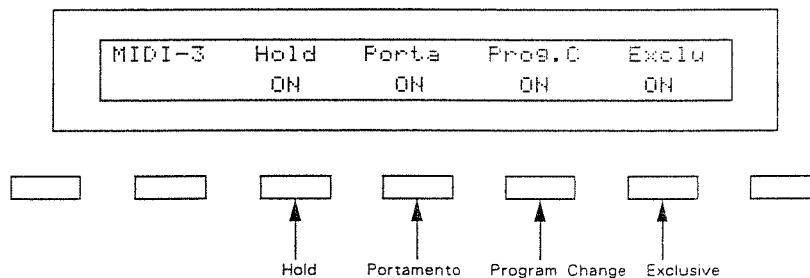
● **Hold**

To receive or transmit Hold messages, set this to ON.

● **Portamento**

To receive or transmit Portamento messages, set this to ON.

● **Program Change**

To receive or transmit Program Change messages, set this to ON. Program Change Numbers correspond to the D-50's Patches as shown in the table on the next page. The program change number to be transmitted can be set for each Patch separately (see page 56). Program change messages are transmitted only when a Patch is selected by operating the D-50's panel buttons, or when the Program change number to be transmitted is altered also on the D-50's panel. In other words, Program change messages are not transmitted by Patch Shift with the pedal switch, or by patch selection with the program change messages sent from an external device.

Memory	Number	1	2	3	4	5	6	7	8
	Bank								
Internal	1	1	2	3	4	5	6	7	8
	2	9	10	11	12	13	14	15	16
	3	17	18	19	20	21	22	23	24
	4	25	26	27	28	29	30	31	32
	5	33	34	35	36	37	38	39	40
	6	41	42	43	44	45	46	47	48
	7	49	50	51	52	53	54	55	56
	8	57	58	59	60	61	62	63	64
Card	1	65	66	67	68	69	70	71	72
	2	73	74	75	76	77	78	79	80
	3	81	82	83	84	85	86	87	88
	4	89	90	91	92	93	94	95	96
	5	97	98	99	100	101	102	103	104
	6	105	106	107	108	109	110	111	112
	7	113	114	115	116	117	118	119	120
	8	121	122	123	124	125	126	127	128

*0 to 127 Program changes can be sent.

● **Exclusive**

To receive or transmit Exclusive messages (Roland ID Number only), set this to "ON" or "P-Dump". Normally, this is set to "ON". "P-Dump" (Patch Dump) should be selected to record patch data into a device that can record Exclusive Messages, such as a computer, the MC-500 (microcomposer), etc. When set to "P-Dump", the Patch you select is transmitted to an external device. However, it cannot be transmitted by Patch Shift with the pedal switch, or by patch selection with the Program change messages sent from an external device.

[MIDI- 4]

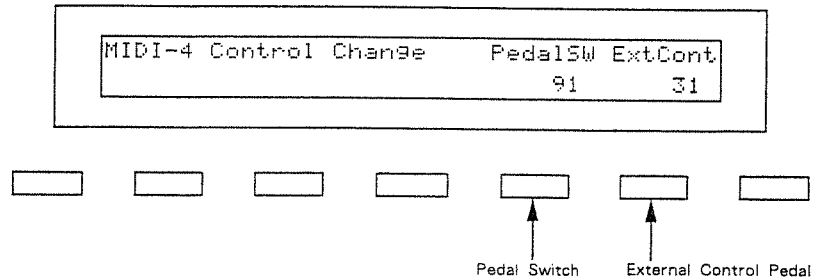

The external MIDI device can be controlled with the pedal switch or external control pedal.

● **Pedal Switch**

With the pedal switch, the Controls from 64 to 95 can be controlled. See the MIDI Implementation Chart at the back of the owner's manual.

● **External Control Pedal**

With the external control pedal, Controls from 0 to 31 can be controlled. See the MIDI Implementation Chart at the back of the owner's manual.

b. MIDI Functions individually set for each Patch

*The edited data does not automatically rewrite the previous Patch, and therefore will be erased when a different Patch is selected, or the unit is turned off. To retain the edited data, take the appropriate writing procedure explained on page 48 "Writing".

Call the MIDI Display (Display 10) in the Patch Factor menu, then call the necessary parameter with the Selector Button, and set the value with the Joystick/Increment and Decrement Buttons.

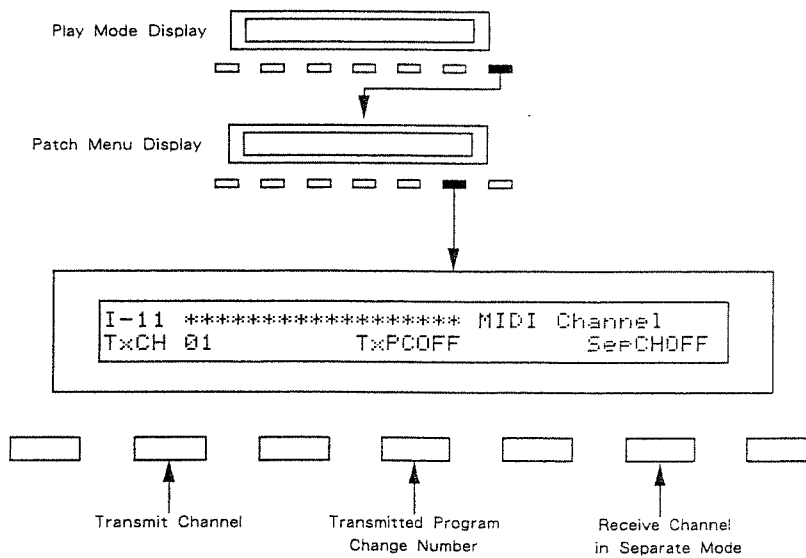

● **Transmit Channel**

The transmit channel of each Patch can be set to a different number from the basic channel. B and 1 to 16 are valid. At B, the channel number is the same as the Basic Channel.

● **Transmitted Program Chnage Number**

A program change number to be transmitted can be set for each Patch individually. OFF and 1 to 100 are valid. At OFF, the program change number preprogrammed in each Patch shown in the table on page 55 is transmitted.

● **Receive Channel in Separate Mode**

A receive MIDI channel in Separate mode can be set for each Patch individually. OFF and 1 to 100 are optional. At OFF, the receive channel set in "MIDI Functions commonly set for all Patches" on page 53 is used.

3. KEY MODE ALTERATION

When the D-50 is being controlled by an external MIDI device, the Key mode selected in each Patch affects how the Tones are played and how the Control messages run as shown in the following pictures.

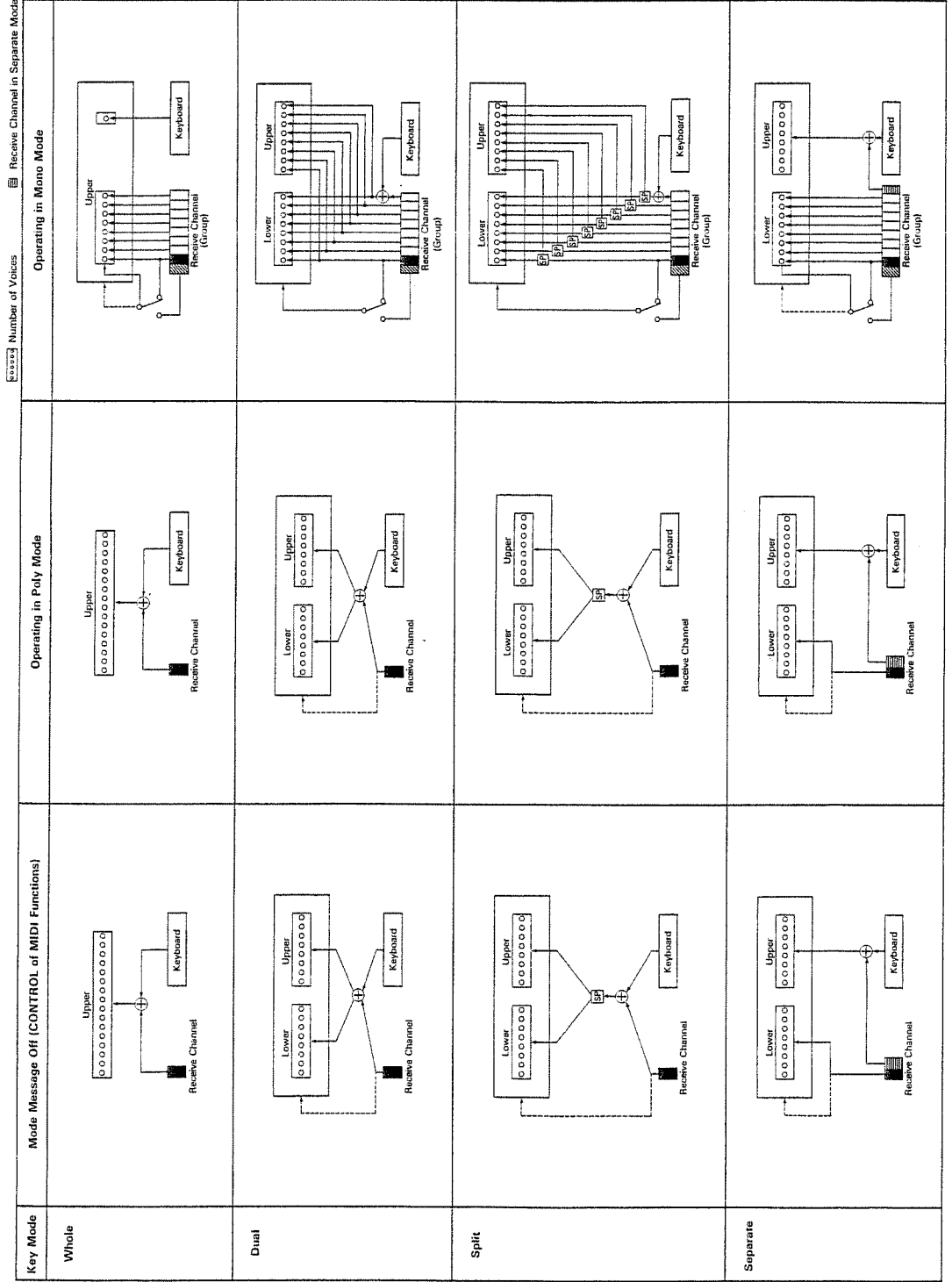

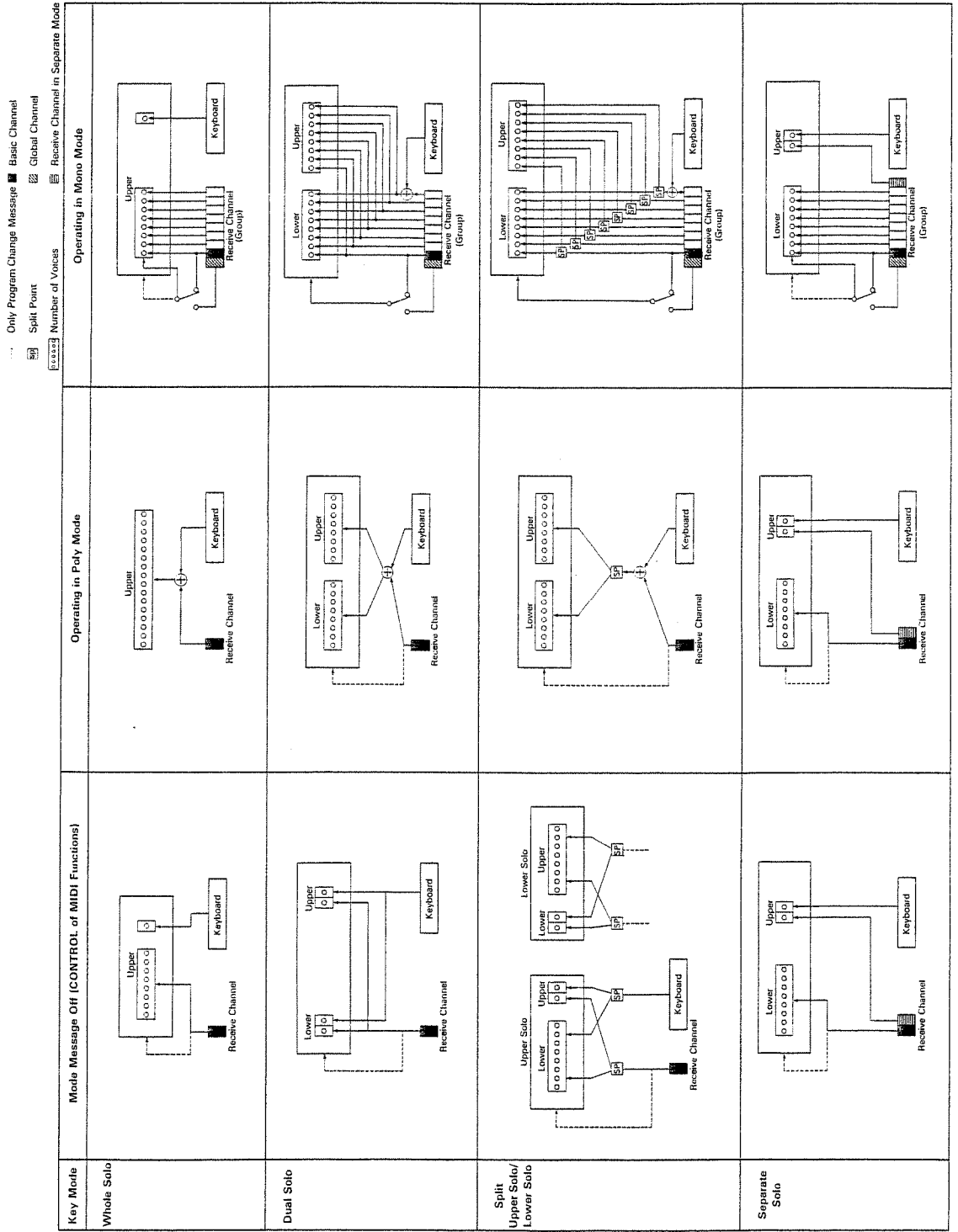

4. DATA TRANSFER WITH MIDI

Using the Roland MIDI Exclusive messages, the data can be transferred from one D-50 to another D-50. Sending data is called Bulk Dump, and receiving data is called Bulk Load.

The Bulk Dump and Bulk Load processes function whether the Exclusive switch in the MIDI Functions is ON or OFF.

There are two methods of data transfer via MIDI; Handshake and One-way.

Handshake allows you to verify whether the receiver is ready to receive the data, while one-way transmits the data without confirming the condition of the receiver. The D-50 can select either of the two methods.

CONNECTION

<Handshake Connection>

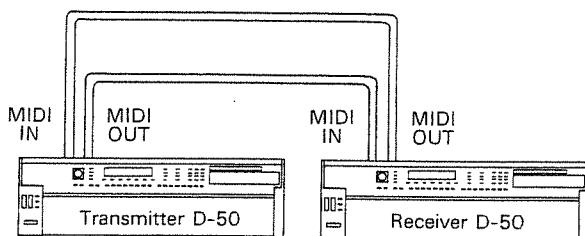

<One-way Connection>

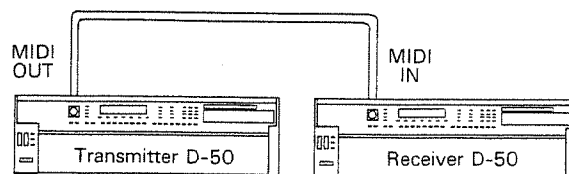

- step 1 Set the Basic Channel of the receiver to the same number as the transmitter's.
- step 2 Set the Memory Protect of the receiver to OFF.(See page 49)
- step 3 Push the Transfer Buttons on both the transmitter and receiver devices.

step 4 Set the receiver to the awaiting signal mode.

● Handshake Mode

1) Select "B. Load" with the corresponding Selector Button.

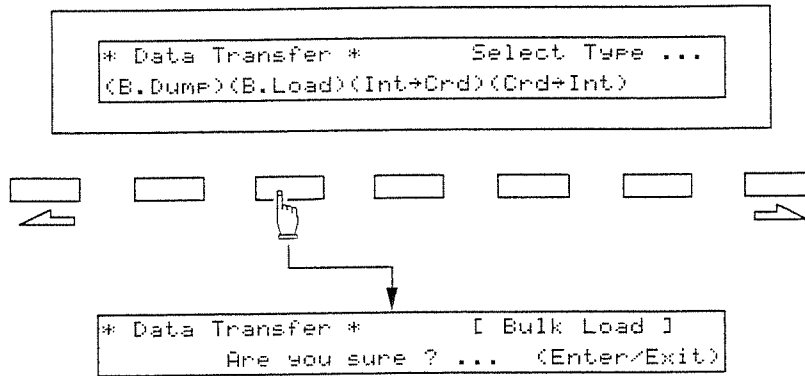

2) Push the Enter Key.

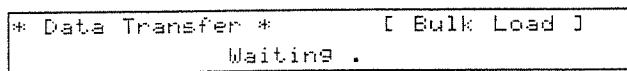

● One-way Mode

1) While holding the Data Transfer Button down, push the Selector Button that corresponds to "B. Load".

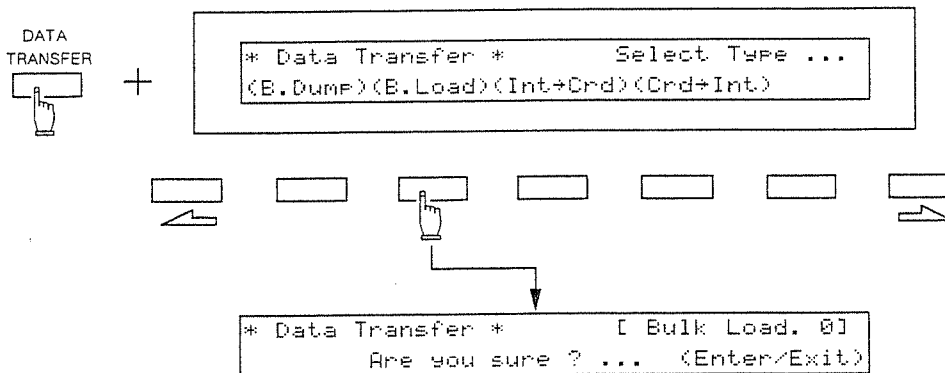

2) Push the Enter Key.

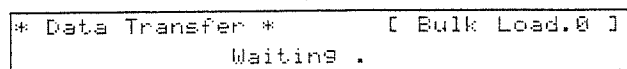

step 5 Set the transmitter to the signal-sending mode.

● Handshake Mode

Select "B. Dump" with the corresponding Selector Button.

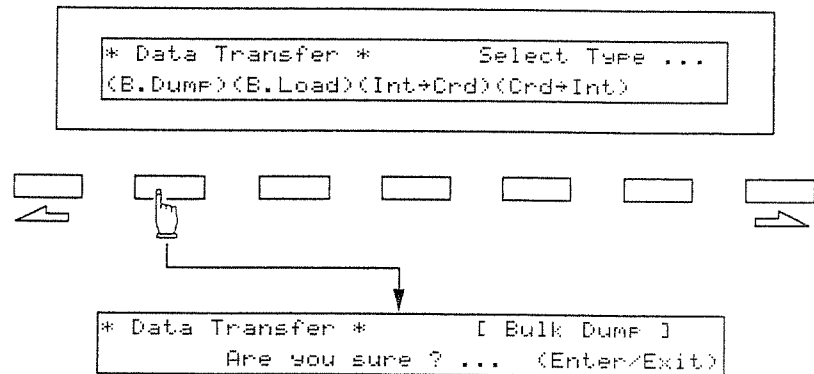

● One-way Mode

While holding the Data Transfer Button down, push the Selector Button that corresponds to "B. Dump".

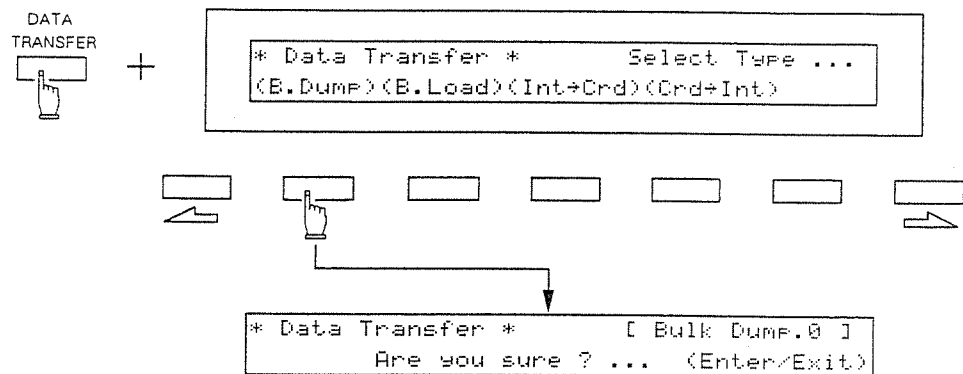

step 6 Push the Enter Key on the transmitter, and the data is transferred.

When the data is correctly transferred, the Display responds as shown below.

● **Handshake Mode**

[Transmitter]

```
* Data Transfer *      [ Bulk Dump ]
      Complete .
```

● **One-way Mode**

[Transmitter]

```
* Data Transfer *      [ Bulk Dump.0 ]
      Complete .
```

[Receiver]

```
* Data Transfer *      [ Bulk Load ]
      Complete .
```

[Receiver]

```
* Data Transfer *      [ Bulk Load.0 ]
      Complete .
```

*When the data fails to be transferred correctly, the Display responds with :

```
MIDI Communication Error
```

Push the Exit Button, then check if the connections are correctly and securely made.

step 7 To return the Display to the play mode, push the Exit Buttons on both the receiver and transmitter devices.

step 8 Return the Memory Protect of the receiver to ON.

6 DATA TRANSFER WITH MEMORY CARD

The entire Patch data written in the D-50's memory can be saved on the Memory Card, and the data on the Memory Card can be loaded into the D-50's internal memory.

The data (Reverb Types) on the sound library (ROM Memory Card) can be copied to the D-50, or from the D-50 to the optional Memory Card (M-256D).

***Please be sure to use the specified Memory Card, such as the supplied Memory Card or M-256D.**

[Available Reverb Types]

A Memory Card can store up to 16 different Reverb Types (17 to 32), as well as 64 Patches. Available Reverb Types differ depending on which Patch is currently in use, Patch in the internal memory or on a Memory Card.

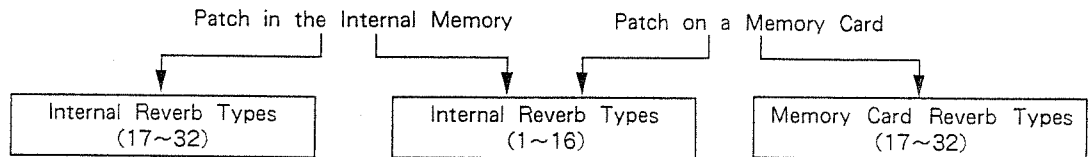

"Patch Transfer" transfers Reverb Types 17 to 32 at the same time, and "Reverb Type Copy" can copy a Reverb Type to any of the 17 to 32 Reverb Types.

1. PATCH TRANSFER

a. Patch Transfer to the Memory Card

All the 64 Patches stored in the D-50's internal memory can be saved onto the optional Memory Card (M-256D) at once. At the same time, 17 to 32 Reverb Types are saved.

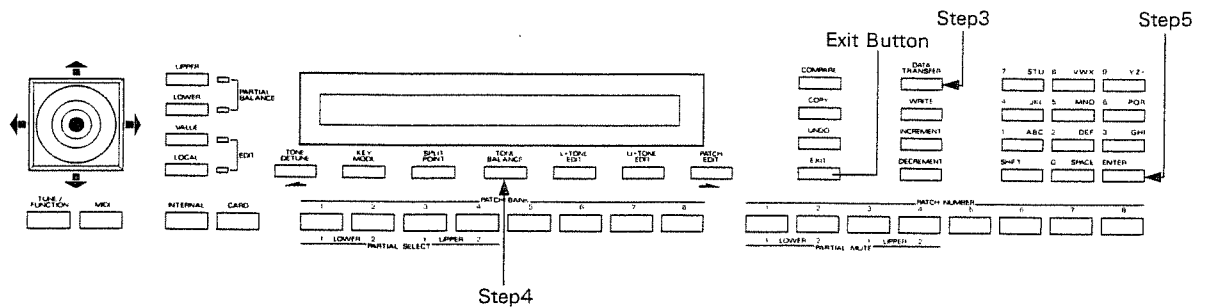

- step 1 **Connect the Memory Card to the D-50.**
- step 2 **Set the Protect Switch on the Memory Card to the OFF position.**
- step 3 **Push the Data Transfer Button.**

* Data Transfer * Select Type ...
 (B.Dump)>(B.Load)>(Int+Crnd)>(Crnd+Int)

step 4 Select "INT → CARD" with the corresponding Selector Button.

```
* Data Transfer *      [ Int → Card ]
  Are you sure ? ... (Enter/Exit)
```

To cancel the data transfer mode, simply push the Exit Button.
 *When you write data onto a Memory Card for the first time, pushing the button will show the following indication for a few seconds, but please carry on the procedure.

```
Illegal Card
```

step 5 Hit the Enter Key.

When the data transfer is completed, the Display changes to as below, then returns to the Play Mode indication.

```
Complete .
```

step 6 Return the Protect Switch on the Memory Cartridge to the ON position.

*When the data fails to be transferred to the Memory Card properly, the Display responds with :

```
* Data Transfer *      [ Int → Card ]
  Verify Error .      (Retry) (Cancel)
```

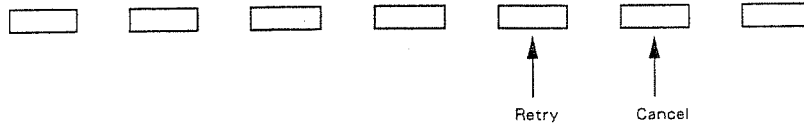

To transfer the data onto the Memory Card again, assign RE TRY with the Selector Button and repeat the transfer procedure after carefully reading the instructions of the Memory Card.

To leave this mode, select CANCEL with the Selector Button.

b. Patch Transfer to the Internal Memory

All the 64 Patches data stored on the Memory Card can be loaded to the D-50's internal memory.

At the same time, Reverb Types (17-32) are loaded.

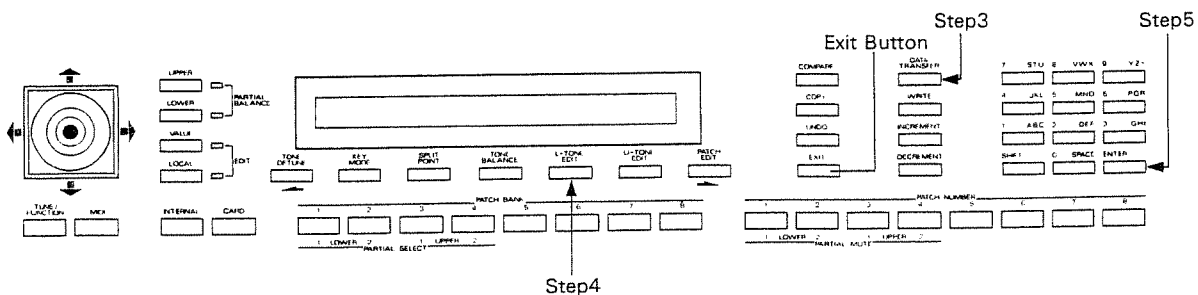

- step 1 Connect the Memory Card to the D-50.
- step 2 Turn the Memory Protect of the D-50 to OFF.(See page 49.)
- step 3 Push the Data Transfer Button.

```

* Data Transfer *      Select Type ...
(B.DUMP)(B.Load)(Int+Crđ)(Crđ+Int)
    
```

- step 4 Select "CARD→INT" with the corresponding Selector Button.

```

* Data Transfer *      [ Card + Int ]
Are you sure ? ... (Enter/Exit)
    
```

To cancel the data transfer mode, simply push the Exit Button.

- step 5 Hit the Enter Key.

When the data transfer is completed, the Display changes as below, then returns to the Play Mode indication.

```

Complete .
    
```

- step 6 Return the Memory Protect of the D-50 to ON.

*When the data fails to be transferred to the D-50 properly, the Display responds with :

```

* Data Transfer *      [ Int + Card ]
Verify Error .      (Retry) (Cancel)
    
```

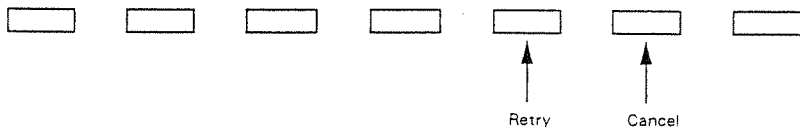

To transfer the data from the Memory Card again, assign REPLY with the Selector Button and repeat the transfer procedure after carefully reading the instructions of the Memory Card.

To leave this mode, select CANCEL with the Selector Button.

2. COPYING A REVERB TYPE

On the optional Sound Library Memory Card (ROM), 32 reverb types (1 to 32) are programmed. 16 (17 to 32) of these reverb types can be copied to the D-50's internal memory. Also, the reverb types written in the D-50's memory can be copied to the optional Memory Card (M-256D).

a. Copying from a Memory Card to the D-50

- step 1 **Connect the Sound Library Memory Card (ROM) to the D-50.**
- step 2 **Turn the Memory Protect of the D-50 to OFF.(See page 49.)**
- step 3 **Call any Patch on the Memory Card.**
- step 4 **Call the Output Mode Display (Display 8), and select one of the Reverb Types (17 to 32) to be copied.**
- step 5 **While holding the Shift Key down, push the Write Button.**

```
C-11 ***** Reverb Write  
Write to [1]17. Sure? (Enter/Exit)
```

Flashing _____ ↑ ↑ _____ Number of destination Reverb Type

- step 6 **Push the Internal Button.**
- step 7 **Push the center Selector Button.(The number of the destination Reverb Type flashes.)**
- step 8 **Using the Joystick/Increment and Decrement Buttons, select the destination Reverb Type (17 to 32) to be replaced with the one called from the Memory Card.**
- step 9 **Hit the Enter Key.**
- step 10 **Return the Memory Protect to ON.**

7 APPENDIX TABLES

1. PATCH FACTOR TABLE

Display	Factor	Value	Reference Page Number	
			Basic course	Advanced course
Play Mode	Key Mode	Whole, Dual, Split, Separate, Whole-S, Dual-S, Split-US, Split-LS, Separate-S	10, 21	57
	Split Point	C2, C#2 ... C7	10, 22	
	Tone Balance	0 ... 100	15, 22	
Tone Tune	L-Tone Key Shift	-24 ... 0 ... +24	23	
	U-Tone Key Shift	-24 ... 0 ... +24	23	
	L-Tone Fine Tune	-50 ... 0 ... +50	23	
	U-Tone Fine Tune	-50 ... 0 ... +50	23	
Patch Name	1 ... 18 (←) (→)	SPACE, A ... Z, a ... z, 1 ... 0, -	20	
Control	Bender Range	0 ... 12	27	
	After Touch (Pitch Bender)	-12 ... 0 ... +12	27	
	Portamento Time	0 ... 100	27	
	Portamento Mode	U, L, UL	27	
	Hold Mode	U, L, UL	27	
Output	Output Mode	1 ... 4	26	
	Reverb Type	1 ... 32 (17 ... 32 Change Type)	26	68, 69
	Reverb Balance	0 ... 100	26	
	Total Volume	0 ... 100	26	
Chase	Chase Mode	UL, ULL, ULU	24	
	Chase Level	0 ... 100	24	
	Chase Time	0 ... 100	24	
MIDI Channel	Transmit CH	Basic CH, 1~16		56
	Transmit Program Change No.	Off, 1 ... 100		56
	Separate Mode Receive CH	Off, 1 ... 16		56

2. TONE PARAMETER TABLE

a. Common Parameters

Display	Tone Parameters	Value	Reference Page Number	
			Basic course	Advanced course
Tone Name	1 ... 10 (←) (→)	SPACE, A ... Z, a ... z, 1 ... 0, -		20
Structure	Structure No.	1 ... 7		4, 22
Pitch ENV	Velocity Range	0 ... 2		23
	Key Follow (Time)	0 ... 4		23
Pitch ENV Time	T1 ... T4	0 ... 50		23, 24
Pitch ENV Level	LO/L1/L2/ Sustain Level/End Level	-50 ... 0 ... +50		23, 24
Pitch Modulation	LFO Depth	0 ... 100		25
	Picth Lever Modulation	0 ... 100		25
	Pitch After Touch Modulation	0 ... 100		25
LFO-1	Waveform	Triangle, Sawtooth, Square, Random		25, 26
	Rate	0 ... 100		25, 26
	Delay Time	0 ... 100		25, 26
	Sync.	Off, On, Key		25, 26
LFO-2	Waveform	Triangle, Sawtooth, Square, Random		25, 26
	Rate	0 ... 100		25, 26
	Delay Time	0 ... 100		25, 26
	Sync.	Off, On		25, 26
LFP-3	Waveform	Triangle, Sawtooth, Square, Random		25, 26
	Rate	0 ... 100		25, 26
	Delay Time	0 ... 100		25, 26
	Sync.	Off, On		25, 26
EQ	Lf	63, 75, 88, 105, 125, 150, 175, 210, 250, 300, 350, 420, 500, 600, 700, 840		27
	Lg	-12 ... 0 ... +12		27
	Hf	250, 300, 350, 420, 500, 600, 700, 840, 1.0, 1.2, 1.4, 1.7, 2.0, 2.4, 2.8, 3.4, 4.0, 4.8, 5.7, 6.7, 8.0, 9.5		27, 28
	HQ	0.3, 0.5, 0.7, 1.0, 1.4, 2.0, 3.0, 4.2, 6.0		27, 28
	Hg	-12 ... 0 ... +12		27, 28
Chorus	Chorus Type	1 ... 8		29
	Chorus Rate	0 ... 100		29
	Chorus Depth	0 ... 100		29
	Chorus Balance	0 ... 100		29

*Partial Mute=On/Off of each Partial (indicated in any Partial Parameter Display)
 Partial Balance= (not indicated in the Display)

APPENDIX TABLES

b. Partial Parameters

Display	Tone Parameters	Value	Reference Page Number	
			Basic course	Advanced course
WG Pitch	Coarse	C1, C#1 ... C7		30
	Fine	-50 ... 0 ... +50		30
	Key Follow	-1, -1/2, -1/4, 0, 1/8, 1/4, 3/8, 1/2, 5/8, 3/4, 7/8, 1, 5/4, 3/2, 2, sl, s2		30, 31
WG Modulation	LFO Mode	Off, (+), (-), A&L (After Touch & Lever)		32
	P-ENV Mode	Off, (+), (-)		32
	Bender Mode	Off, Key Follow, Normal		32, 33
WG Waveform	Waveform	Square, Sawtooth		33
	PCM Wave No.	1 ... 100 (PCM Name)		33, 34
WG Pulse Width	Pulse Width	0 ... 100		35
	Velocity Range	-7 ... 0 ... +7		35
	After Touch Range	-7 ... 0 ... +7		35, 36
	LFO Select	+1, -1, +2, -2, +3, -3		35, 36
	LFO Depth	0 ... 100		35, 36
TVF	Cutoff Frequency	0 ... 100		36, 37
	Resonance	0 ... 30		36, 37
	Key Follow	-1, -1/2, -1/4, 0, 1/8, 1/4, 3/8, 1/2, 5/8, 3/4, 7/8, 1, 5/4, 3/2, 2		36, 38
	Bias Point/Bias Direction	<A1 ... <C7, >A1 ... >C7		36, 39
	Bias Level	-7 ... 0 ... +7		36, 39
TVF ENV	Depth	0 ... 100		39, 40
	Velocity Range	0 ... 100		39, 40
	Key Follow (Depth)	0 ... 4		39, 40
	Key Follow (Time)	0 ... 4		39, 40
TVF ENV Time	T1 ... T5	0 ... 100		41, 42
TVF ENV Level	L1/L2/L3/ Sustain Level	0 ... 100		41, 42
	End Level	0, 100		41, 42
TVF Modulation	LFO Level	+1, -1, +2, -2, +3, -3		42, 43
	LFO Depth	0 ... 100		42, 43
	After Touch Range	-7 ... 0 ... +7		43
TVA	Level	0 ... 100		43
	Velocity Range	-50 ... 0 ... +50		43
	Bias Point/Bias Direction	<A1 ... <C7, >A1 ... >C7		43, 44
	Bias Level	-12 ... 0		43, 44
TVA ENV Time	T1 ... T5	0 ... 100		44~46
TVA ENV Level	L1/L2/L3/ Sustain Level	0 ... 100		44~46
	End Level	0, 100		44, 46
TVA ENV	Velocity Follow (Time1)	0 ... 4		46
	Key Follow (Time)	0 ... 4		46
TVA Modulation	LFO Select	+1, -1, +2, -2, +3, -3		47
	LFO Depth	0 ... 100		47
	After Touch Range	-7 ... 0 ... +7		47

3. MIDI FUNCTION TABLE

Display	MIDI Functions	Value	Reference Page Number	
			Basic course	Advanced course
MIDI-1	MIDI CH	1 ... 16		52
	Control	Basic CH, Global CH, Mode Message Off		52, 53
	Separate Mode Receive CH	1 ... 16		56
	Omni	Off, On		52, 53
	Local	Off, On		52, 53
MIDI-2	After Touch	Off, On		54
	Bender	Off, On		54
	Modulation	Off, On		54
	Volume	Off, On		54
MIDI-3	Hold	Off, On		54
	Portamento	Off, On		54
	Program Change	Off, On		54
	Exclusive	Off, On, Patch Dump		54
MIDI-4 Control Change	Pedal SW	64 ... 95		55
	External Control	0 ... 31		55

4. ERROR MESSAGE TABLE

Display	Discription
<div style="border: 1px solid black; padding: 5px; text-align: center;">Check Internal Battery</div>	The back-up battery in the D-50 is low. Consult your local Roland Service Department.
<div style="border: 1px solid black; padding: 5px; text-align: center;">Check Card's Battery</div>	The back-up battery (CR 2016) in the optional Memory Card (M-256D) is low. Replace it with a new one as shown in the instructions of the Memory Card.
<div style="border: 1px solid black; padding: 5px; text-align: center;">Int Memory Protected</div>	You have tried to write data into the D-50's memory with the Memory Protect on the D-50 set to ON. Set Memory Protect to OFF.
<div style="border: 1px solid black; padding: 5px; text-align: center;">Card Memory Protected</div>	You have tried to write data onto the Memory Card with the Memory Protect Switch on the Memory Card in the ON position. Set it to OFF.
<div style="border: 1px solid black; padding: 5px; text-align: center;">Card Not Ready</div>	The Memory Card is not connected securely.
<div style="border: 1px solid black; padding: 5px; text-align: center;">Set key mode WHOLE or DUAL</div>	You pushed the Chase Button in a mode other than Whole or Dual Key Mode. Select the Whole or Dual Key Mode.
<div style="border: 1px solid black; padding: 5px; text-align: center;">Input Data Error Cancel ...</div>	You have assigned a value that exceeds the valid range.
<div style="border: 1px solid black; padding: 5px; text-align: center;">Data Mismatch Cancel ...</div>	The destination Block you have selected differs from the source Block. Reselect the appropriate Block, and repeat Block Copy.
<div style="border: 1px solid black; padding: 5px; text-align: center;">MIDI Communication Error</div>	Data is not transferred properly. Push the Exit Button, check if the connections are correctly and securely made and repeat the transfer procedure.
<div style="border: 1px solid black; padding: 5px; text-align: center;">Verify Error . (Retry) (Cancel)</div>	Data is not properly loaded or saved between the internal memory of the D-50 and the Memory Card. Read the instructions of the Memory Card, push the relevant Selector Button (Retry) and carefully repeat the loading or saving. To leave the transfer mode, push the relevant Selector Button (Cancel).
<div style="border: 1px solid black; padding: 5px; text-align: center;">Illegal Card</div>	This is shown when you are using a brand-new card or the card that contains the data for other than the D-50.

5. SAMPLE NOTE

Patch No. _____

Patch No. _____

Patch No. _____

Patch Name _____

Patch Name _____

Patch Name _____

Key Mode	
Split Point	
Tone Balance	

Key Mode	
Split Point	
Tone Balance	

Key Mode	
Split Point	
Tone Balance	

L-Key Shift	
U-Key Shift	
L- Fine Tune	
U-Fine Tune	

L-Key Shift	
U-Key Shift	
L-Fine Tune	
U-Fine Tune	

L-Key Shift	
U-Key Shift	
L-Fine Tune	
U-Fine Tune	

Bender Range	
After(Pitch Bender)	
Portamento Time	
Portamento Mode	
Hold Mode	

Bender Range	
After(PitchBender)	
Portamento Time	
Portamento Mode	
Hold Mode	

Bender Range	
After(Pitch Bender)	
Portamento Time	
Portamento Mode	
Hold Mode	

Output Mode	
Reverb Type	
Reverb Balance	
Total Volume	

Output Mode	
Reverb Type	
Reverb Balance	
Total Volume	

Output Mode	
Reverb Type	
Reverb Balance	
Total Volume	

Chase Mode	
Chase Level	
Chase Time	

Chase Mode	
Chase Level	
Chase Time	

Chase Mode	
Chase Level	
Chase Time	

MIDI TxCH	
MIDI TxProg.C	
MIDI SepCH	

MIDI TxCH	
MIDI TxProg.C	
MIDI SepCH	

MIDI TxCH	
MIDI TxProg.C	
MIDI SepCH	

Used Tone

Used Tone

Used Tone

Upper _____

Upper _____

Upper _____

Lower _____

Lower _____

Lower _____

 Roland®

10481

UPC 10481

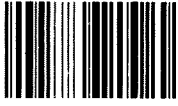

10901

 Roland