



MIDI KEYBOARD CONTROLLER

A-33

Owner's Manual

For the USA

FEDERAL COMMUNICATIONS COMMISSION RADIO FREQUENCY INTERFERENCE STATEMENT

This equipment has been tested and found to comply with the limits for a Class B digital device, pursuant to Part 15 of the FCC Rules. These limits are designed to provide reasonable protection against harmful interference in a residential installation. This equipment generates, uses, and can radiate radio frequency energy and, if not installed and used in accordance with the instructions, may cause harmful interference to radio communications. However, there is no guarantee that interference will not occur in a particular installation. If this equipment does cause harmful interference to radio or television reception, which can be determined by turning the equipment off and on, the user is encouraged to try to correct the interference by one or more of the following measures:

- Reorient or relocate the receiving antenna.
- Increase the separation between the equipment and receiver.
- Connect the equipment into an outlet on a circuit different from that to which the receiver is connected.
- Consult the dealer or an experienced radio/TV technician for help.

Unauthorized changes or modification to this system can void the users authority to operate this equipment.

For Canada

CLASS B NOTICE

This digital apparatus does not exceed the Class B limits for radio noise emissions set out in the Radio Interference Regulations of the Canadian Department of Communications.

CLASSE B AVIS

Cet appareil numérique ne dépasse pas les limites de la classe B au niveau des émissions de bruits radioélectriques fixés dans le Règlement des signaux parasites par le ministère canadien des Communications.

For E.C. Countries

This product complies with EC directives
- EMC 89/336"

Dieses instrument entspricht folgenden EG-Verordnungen:
- EMC 89/336"

Cet instrument est conforme aux directives CE suivantes:
- EMC 89/336"



Questo prodotto è conforme alle seguenti direttive CEE
- EMC 89/336"

Dit instrument beantwoordt aan de volgende EG richtlijnen:
- EMC 89/336"

Este producto cumple con las siguientes directrices de la CE
- EMC 89/336"

Copyright © 1999 by ROLAND CORPORATION

All rights reserved. No part of this publication may be reproduced in any form without the written permission of ROLAND CORPORATION.

English	Page	5
Deutsch	Seite	39
Français	Page	73
Italiano	Pagina	107
32 Factory Patches		141
MIDI Implementation Chart		149
MIDI Implementation Guide		151
Roland Distributors		155

Roland®

MIDI KEYBOARD CONTROLLER

A-33

OWNER'S MANUAL

Thank you, and congratulations on your choice of the Roland A-33. The A-33 is an easy-to-operate, dedicated keyboard controller for GS compatible sound modules. Please take the time to read through this Owner's Manual. That way you can feel assured that you understand every feature the unit offers, and will enjoy many years of trouble-free operation.

ABOUT THE A-33

The Roland A-33 is a MIDI keyboard controller. It does not contain any sound-generating circuitry since it is designed to transmit note messages, program changes, bank select messages, as well as a variety of other MIDI messages (such as reverb and chorus send levels) to an external sound module. It is particularly suited for controlling sound modules that comply with the GS Format. (Let us agree to call them "GS sound modules".)

What is the GS Format?

The GS Format is a standardized set of specifications for Roland's sound sources which defines the manner in which multitimbral sound modules will respond to MIDI messages. All devices compatible with the GS Format bear the GS logo. Every module or instrument bearing the GS logo will respond in the same way to the MIDI messages sent from the A-33.

- * All Roland GS sound modules also fully support Level 1 of the General MIDI System.
- * In 1990, bank select messages were added to the MIDI standard to allow users to select a much larger number of sounds than was originally possible with program changes. Using bank select numbers 0 and 32 as well as program change messages, you can select more than 16,000 sounds – a lot more than the 128 selectable using only program change messages. The GS Format accommodates this form of sound selection. However, bank select messages cannot be used for the Drum Part (usually MIDI channel 10).

About the Sounds Contained in a GS Sound Module

A GS sound module contains 128 basic sounds (Capital Tones) and a number of Variation Tones. The mapping of the Capital Tones is compatible with Level 1 of the General MIDI System, so that memory 1 always contains a piano sound, memory 17 an organ, etc. Capital Tones are stored in Bank 0, while the Variations are stored in Banks 1~127. The available Variation Tones will be different depending on the sound module. You should check the manual of any module you wish to use, and familiarize yourself with the sounds it contains.

About the Drum Sets Provided by a GS Sound Module

The Drum Part (MIDI channel 10) provides for the use of several Variation Drum Sets in addition to the basic Drum Set (Standard Set: PC #1). Drum Sets are selected using program change messages. The types of Variation Sets depend on the sound module you use. Refer to the manual of your module to find out which Drum Sets it contains.

- * If a Variation Tone or Variation Drum Set you have requested does not exist on the GS module you are using, the module may not sound at all, or an incorrect sound may be played.

Main Features of the A-33

Superb Playability and Expressiveness

Since this standard 76-key keyboard also provides response to velocity, the A-33 allows you to express even the finest nuances. In addition, an Octave Shift feature allows you to conveniently shift the soundable range up or down one or two octaves. Moreover, the A-33 is equipped with a Pitch Bend/Modulation lever, and provides two jacks for connecting a damper pedal and an expression pedal. It also includes two separate MIDI OUT sockets that can be switched on or off on the front panel, to be used for a convenient connection to several sound modules.

Complete Range of Control Features

Since the keyboard provides for sound selection that uses combinations of program change and bank select messages (value for CC 00 and CC 32), you can also select any of the Variation Tones available on a GS sound module. Two sections, Upper and Lower, can be set separately, allowing you to control two different sounds in Split or Layer mode.

In addition, a variety of Control Change numbers can be assigned to the DATA ENTRY slider. The slider can then be used to control the desired parameter (Reverb or Chorus Depth, for example) on a GS sound module.

Makes Desk Top Music (DTM) More Enjoyable

The A-33 can be powered either with an optional adaptor or batteries. The A-33 is sure to become an invaluable part of any DTM setup, since it can be used for real-time or step recording, as well as for practice while listening to "Minus-One" playback of Standard MIDI Files.

Copyright © 1996 Roland Corporation

All rights reserved. No part of this publication may be reproduced in any form without the written permission of Roland Corporation.

IMPORTANT NOTES

When using an AC adaptor, use only the specified device (BOSS ACA series). Use of any other AC adaptor could result in damage, malfunction or electric shock.

Power Supply

- Before connecting this unit to other devices, turn off the power to all units; this will help to prevent damage or malfunction.
- Do not use this unit on the same power circuit as any device that generates line noise (an electric motor or variable lighting system for example).
- The power requirements for this unit are indicated on its nameplate (rear panel). Ensure that the voltage in your country meets these requirements.
- Avoid damaging the power cord: do not step on it, place heavy objects on it, etc.
- When disconnecting the AC adaptor from the power outlet, grasp the adaptor itself; never pull on the cord.
- If the unit is to remain unused for an extended period of time, unplug the adaptor from the wall outlet.
- When installing or replacing batteries, refer to "Battery Replacement" (page 12).

Placement

- Do not subject the unit to temperature extremes (e.g. direct sunlight in an enclosed vehicle). Avoid using or storing the unit in dusty or humid areas, or areas that are subject to high levels of vibration.
- Using the unit near power amplifiers may induce hum.
- This device may interfere with radio and television reception. Do not use this device in the vicinity of such receivers.

Maintenance

- For everyday cleaning, wipe the unit with a soft, dry cloth or one that has been slightly dampened with water. To remove stubborn dirt, use a mild, non-abrasive detergent. Afterwards, be sure to wipe the unit thoroughly with a soft, dry cloth.
- Never use benzene, thinners, alcohol or solvents of any kind, to avoid the possibility of discoloration and/or deformation.

Additional Precautions

- Protect the unit from strong impact.
- Do not allow objects or liquids of any kind to penetrate the unit. In the event of such an occurrence, discontinue use immediately. Contact qualified service personnel as soon as possible.
- A small amount of heat will radiate from the unit during normal operation.
- Before using the unit in a foreign country, consult with qualified service personnel.
- Should a malfunction occur, or if you suspect there is a problem, discontinue use immediately. Contact qualified service personnel as soon as possible.
- To avoid the risk of electric shock, do not open the unit.

TABLE OF CONTENTS

About the A-33	6
Important Notes	8
Panel Descriptions	11
Power	12
Setting Up the A-33	13
MIDI Channel (MIDI Transmit Channel) and Keyboard modes	15
Setting the MIDI channel	
Using the Upper and Lower sections (KBD Mode)	16
Split mode	17
Layer mode	18
MIDI Out 1 and MIDI Out 2 connectors	18
Selecting Sounds on a GS Sound Module	19
Selecting Sounds on a GS Sound Module	
Selecting Drum Sets in a GS Sound Module	20
Performance functions	21
Using glides: Pitch Bend	
Adding vibrato: Modulation (CC01)	
Sustaining notes: Damper (CC 64)	22
Changing the volume of a Part: Expression	
Enabling or disabling the transmission of certain MIDI messages	
Octave Shift (changing Octaves)	24
Transposing the A-33's keyboard	
Controlling a Sound Module with the DATA ENTRY Slider	25
Changing the Velocity Sensitivity: Velocity Curve	
Changing the Reverb Depth: Reverb Send Level (CC 91)	26
Changing the Chorus Depth: Chorus Send Level (CC 93)	
Changing the Volume: Volume (CC 07)	27
Setting the Sound Location: Panpot (CC 10)	
Switching the Chorus/Reverb effect on/off	
Assigning Other Functions (CC 00~127) to the DATA ENTRY Slider	29
Assigning modulation or aftertouch to the Modulation axis of the lever	30
Controlling an external sequencer	31
Using the Patch memories	33
Storing settings in a Patch memory	33
How to recall a Patch memory setting	34
Default Settings	
Restore Factory settings	

Transmitting the A-33's settings via MIDI (Data Dump)	35
Battery life check	35
Troubleshooting	36
Specifications	38
32 Factory Patches	141
MIDI Implementation Chart	149
MIDI Implementation Guide	151
Roland World Distributors	157

PANEL DESCRIPTIONS

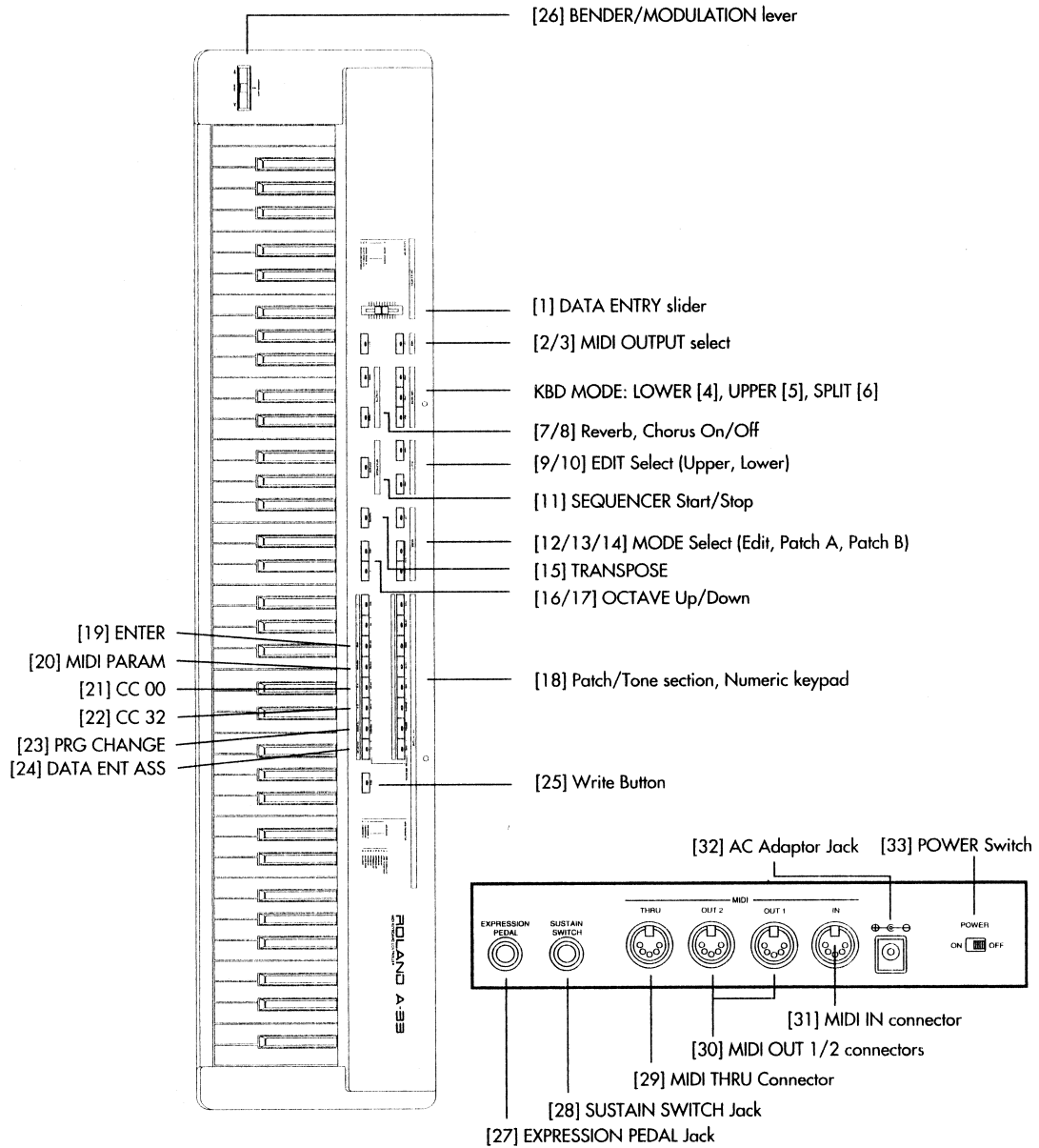

POWER

The A-33 can be powered either by batteries or an AC adaptor.

Battery replacement

Six AA batteries are required to run the unit on battery power. We recommend the use of alkaline batteries because they will provide a more stable, long-lasting source of power. With alkaline batteries, you can expect about 25 hours of continuous operation, although this depends on how the unit is being used.

- * Avoid using new batteries together with old ones. In addition, avoid mixing different types of batteries (e.g. regular carbon and alkaline batteries).
- * When replacing batteries, be sure to insert them correctly (ensure correct polarity).
- * Remove the batteries whenever the unit is to remain unused for an extended period of time.

1. Check that the unit is OFF.
2. Remove the battery cover located on the bottom of the instrument.

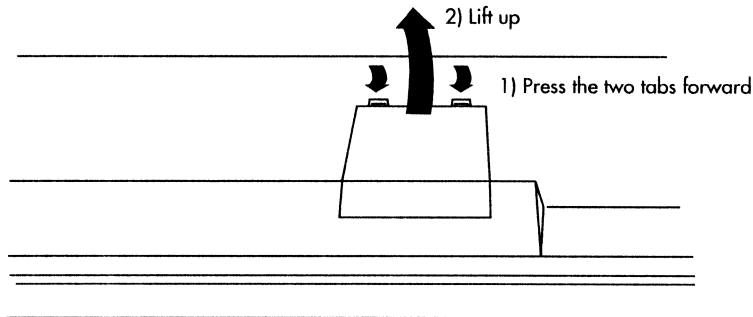

3. Take out the battery case, then insert the six batteries (three on either side).

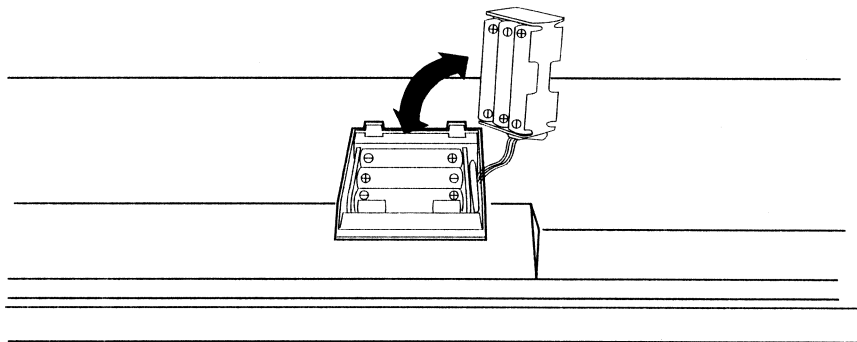

4. Close the battery cover.

Connecting an optional AC adaptor

Be sure to use only the specified AC adaptor (BOSS ACA series). Using any other type may cause malfunction or electric shock.

* If the unit is to remain unused for an extended period of time, unplug the adaptor.

1. Check that the unit is OFF.
2. First connect the AC adaptor to the A-33's AC Adaptor jack [32], then connect the plug to a power outlet.

SETTING UP THE A-33

The A-33 is a MIDI controller. Although it contains no sound-generating circuits of its own, it can control external MIDI units (sound modules, computers, etc.) by transmitting a wide variety of MIDI messages.

To ensure maximum benefit from your system, be sure to read this manual and the manuals of all external devices.

Sound Module Setup

Connect the A-33's MIDI OUT 1 or 2 [30] socket to the MIDI IN connector of the sound module.

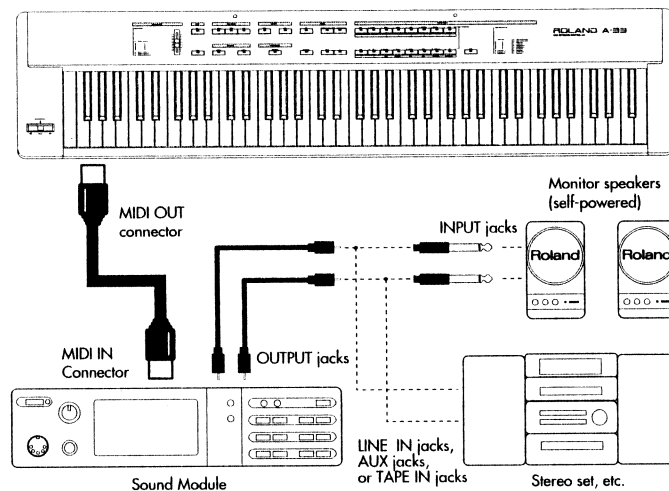

Desk Top Music Setup

- * When connecting your computer to a sound module, use only a cable which is designed for the model of computer you are using and its particular kind of connector.

- * If the sound module has a COMPUTER switch, make sure it is set to the appropriate position. This depends on the type of computer, the way you are using it, and the requirements of the software you are using.

Computer connected using the serial connector on the sound module

Connect the A-33's MIDI OUT 1 or 2 [30] connector to the MIDI IN connector of the sound module.

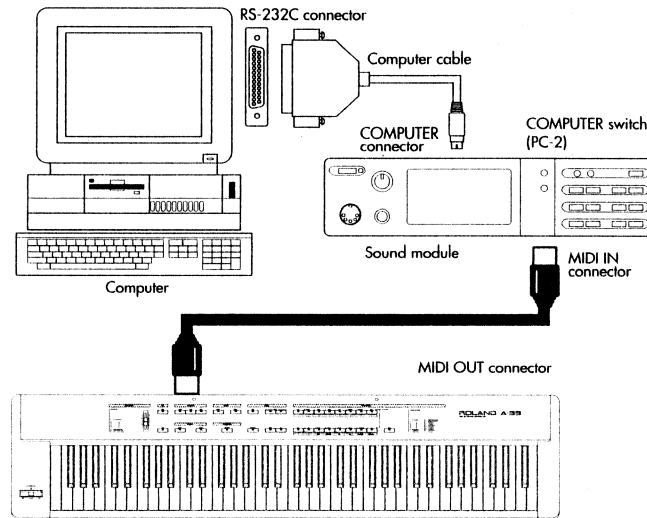

Computer connected to the MIDI IN socket on the sound module

Connect the A-33's MIDI OUT 1 or 2 [30] connector to the MIDI IN connector on the MIDI interface (MPU series, or the like).

Powering Up

Power to the various devices should be turned on in the appropriate order. First, turn on the units that transmit MIDI messages (computer, A-33). Next, turn on the sound module(s), then the amplification system. The A-33's power switch [33] is located on its rear panel.

Power off your system in the reverse order.

- * *This unit is equipped with a circuitry protection feature. At power-up a brief interval is required before the unit will operate normally.*

MIDI CHANNEL (MIDI TRANSMIT CHANNEL) AND KEYBOARD MODES

Setting the MIDI channel

To ensure that the module or Part you want to control receives the messages you send from the A-33, you have to select the MIDI channel your module (or one of its Parts) receives on. Note that the A-33 can transmit on two MIDI channels at the same time. To this end, it sports two sections called Upper and Lower. Always make sure the A-33's Upper and Lower MIDI channels have the same number as the Parts of the external module you wish to control.

[Procedure]

1. Press MODE EDIT [12] (indicator lights).
2. Press SELECT UPPER [10] or LOWER [9] to choose the section whose MIDI transmit channel you want to set.
3. Press the MIDI/PARAM button [20] (indicator lights).
4. Enter the MIDI channel by pressing the corresponding PATCH/TONE button [18] (1~16).
** Here, every PATCH/TONE button selects a MIDI channel number (1~16). In other words, there is no need to enter two digits for channel numbers 10~16: just press button "10"~"16".*
5. Press ENTER [19] to confirm the MIDI channel selection.
6. Press EDIT [12] again (the LED will go out).
Use the same procedure, this time selecting the Lower section, to set the MIDI channel for the Lower section

Note: You cannot select the same MIDI channel for both sections.

Example: If you set the Upper MIDI channel to 4 and you try to assign the same number to the Lower section, the MIDI/PARAM indicator [20] will flash.

Using the Upper and Lower sections (KBD Mode)

A-33 features three keyboard modes: Upper, Lower, and Split.

The **Upper Mode** allows you to send MIDI data on the MIDI channel assigned to the Upper section.

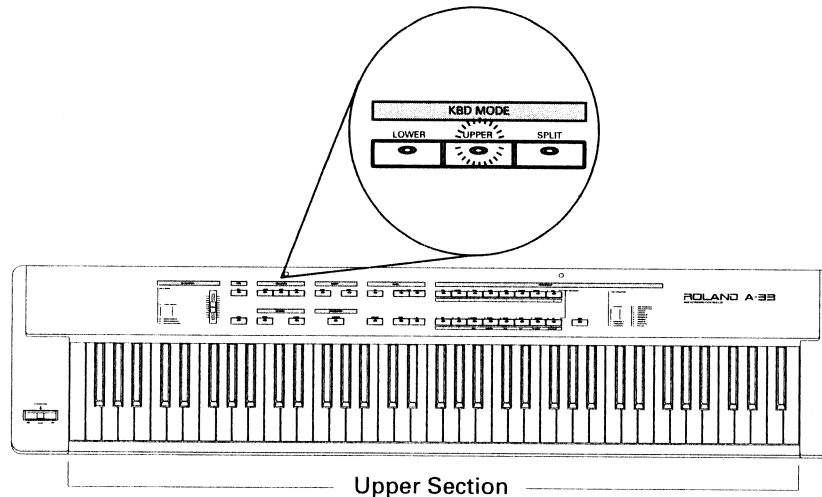

The **Lower Mode** allows you to transmit on a different MIDI channel.

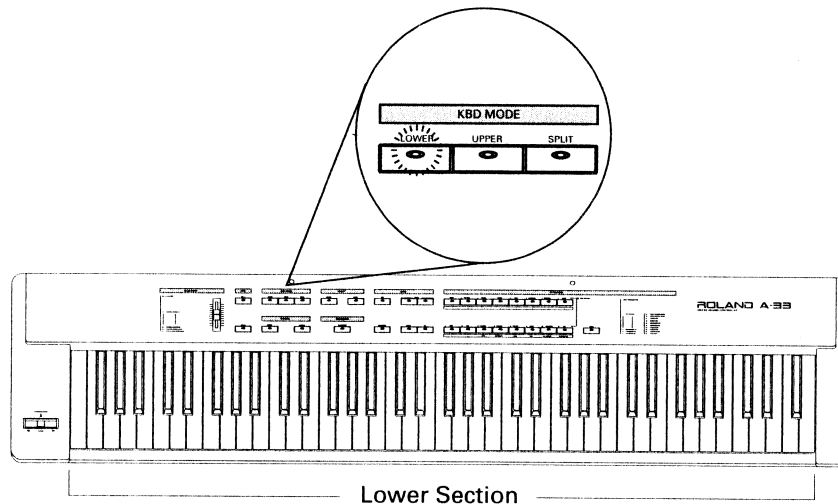

The Upper and Lower sections can be used in three ways: (i) in isolation (either Upper or Lower section), (ii) in combination (Upper + Lower section= *Layer*), or (iii) in *Split* mode (Lower for the left hand and Upper for the right hand). Using the Upper and Lower sections in isolation allows you to quickly “select” another MIDI channel without performing the steps outlined under “Setting the MIDI channel”, which is convenient in a live situation.

Also note that the following parameters can be set for each section individually, thus greatly expanding the scope of your A-33:

- MIDI channel
- Octave Shift
- MIDI parameters 17/18 (P BEND MOD ON/OFF)
- MIDI parameters 21/22 (SUSTAIN/OFF)
- MIDI parameters 23/24 (EXPRESSION ON/OFF)

Split mode

The Split Mode divides the keyboard into two sections: the Upper section for your right hand and the Lower section for your left hand. Press the SPLIT button [6] to call up the Split mode (indicator lights).

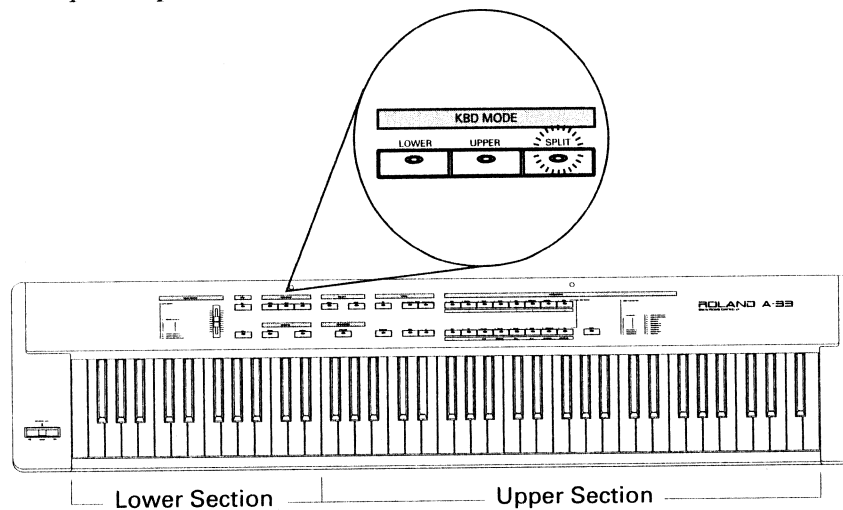

Setting the Split point

When the "Split" Keyboard Mode is active, the keyboard is divided into two sections. The Lower section transmits note messages for the keys/notes E-1 to B3, while the Upper Section transmits note messages for the keys/notes C4 to G7. You may, however, set a different Split point.

[Procedure]

1. Press and hold the KBD Mode SPLIT button [6] (the LED will flash).
2. Press the keyboard key that is to become the Split point.
3. Release the "SPLIT" button and the key.

Layer mode

You can also use both sections (Upper and Lower) at the same time, which is called “layering”. In the Layer mode, the A-33 will send note information on two MIDI channels. That also explains why it is impossible to assign the same MIDI channel to the Upper and Lower sections: it wouldn’t make sense to send the same information to an instrument or Part twice.

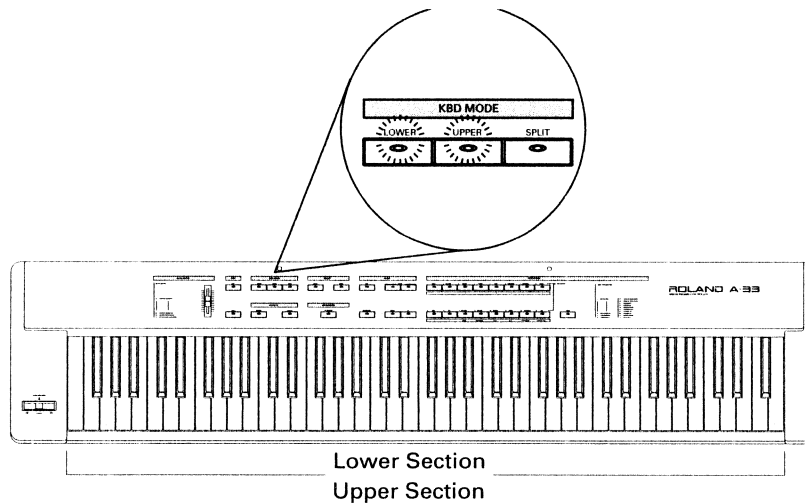

To select the Layer mode, set on both KBD Mode UPPER and LOWER .

To return to the Upper or Lower mode, set off one of the KBD Modes.

MIDI OUT 1 AND MIDI OUT 2 CONNECTORS

A-33 is equipped with two MIDI OUT sockets that can be separately switched On or Off using the MIDI OUT 1 [2] and MIDI OUT 2 [3] buttons located on the front panel. Both MIDI OUT sockets send the same MIDI messages (parallel connection) but can be switched on or off individually.

You could take advantage of these two MIDI OUT sockets to avoid transmission delays due to MIDI “daisy chains” (a serial connection between the MIDI IN and MIDI THRU connectors of several instruments).

Furthermore, you could use this facility to alternate between two instruments by simply transmitting the A-33’s MIDI messages to the MIDI OUT socket the module you wish to control is connected to. The on/off setting for the MIDI OUT sockets can be stored in the A-33’s 32 Patch memories, along with a lot of other settings. See “Storing settings in a Patch Memory” on page 33.

SELECTING SOUNDS ON A GS SOUND MODULE (PROGRAM CHANGE/BANK SELECT)

Program Change/Bank Select messages are used to select Tones (for “melodic” Parts) or Drum Sets (for Drum Parts, usually assigned to MIDI channel 10) via MIDI.

Selecting Sounds on a GS Sound Module

If you want to change Tones in a GS module, you need to send Bank Select messages (values for control change numbers CC00 and CC32) along with a program change number.

The value for CC00 (MSB) and that for CC32 (LSB) work together as a pair to specify a Variation or the Capital bank. Please note that bank selection alone is not enough to call up sounds. Bank Select messages need to be followed by a Program Change number.

On the A-33, these three messages are always sent as a set (let us agree to call them “sound select clusters”):

Value for control change number CC00 (MSB)

Value for control change number CC32 (LSB)

Program Change number

* *These messages can be sent on the Upper or Lower section.*

[Procedure]

1. Press the SELECT LOWER [9] or SELECT UPPER [10] button to select the section you wish to use for sending the sound select cluster. The choice of the section (Upper or Lower) determines the MIDI channel the sound select cluster will be transmitted on.
2. If necessary, set the MIDI transmit channel to match that of the desired Part of the module.
3. Press the MODE EDIT [12] button (indicator lights).
4. Press the CC32 button [22] (indicator lights).
5. Specify the value of control change CC32 using the 0~9 buttons in the PATCH/TONE section [18].
6. Press ENTER [19].
7. The indicator of the CC00 button [21] will light.
8. Specify the value of control change CC00 using the 0~9 buttons in the PATCH/TONE section [18].
9. Press ENTER [19].
10. Now the indicator of the PRG CHANGE button [23] lights.

11. Select the Program Number using the 0~9 buttons in the PATCH/TONE section [18].
12. Press ENTER [19].
13. Press the MODE EDIT button [12] again (the LED will go out).

[Example]

Let us select Variation no. 8, Instrument no. 3 sound (Piano 3w) on the SC-55mkII:

1. Set the MIDI transmit channel to match that of the desired Part.
2. Press the MODE Edit [12] button (indicator lights).
3. Press the CC32 button [22] (indicator lights).
4. Press the "0" key in the PATCH/TONE section [18].
5. Press ENTER [19].
6. The CC00 button indicator lights.
7. Press the "8" button in the PATCH/TONE section [18].
8. Press ENTER [19].
9. The PRG CHANGE button LED will light.
10. Press the "3" button in the PATCH/TONE section [18].
11. Press ENTER [19].
12. Press the MODE Edit [12] button again (the LED will go out).

* *There is no need to transmit Bank Select messages whenever you wish to select a sound that is in the currently selected bank. In that case, press PRG CHANGE [23] and specify the number.*

Selecting Drum Sets in a GS Sound Module

The Drum Part (MIDI channel 10) of a GS module does not respond to Bank Select messages. However, if you try to send only a Program Change message from the A-33, a Bank Select message will end up being transmitted along with it anyway because the data for the last sound specified will have been retained in memory. For this reason, you should always send the value 0 for control change numbers CC00 and CC32 first, then send the Program number to ensure you obtain the Drum Set you need.

[Procedure]

1. Press the "Select LOWER" [9] or "Select Upper" [10] button to select the section (Upper or Lower) you wish to use for sending the sound select cluster.
2. Set the MIDI transmit channel to 10.
3. Press the MODE EDIT [12] button (indicator lights).
4. Press the CC32 button [22] (indicator lights).
5. Enter the value for control change number CC32 using the 0~9 buttons in the PATCH/TONE section [18].

6. Press ENTER [19].
7. The CC00 button LED [21] will light.
8. Select the value of control change number CC00 using the 0~9 buttons in the PATCH/TONE section [18].
9. Press ENTER [19].
10. The PRG CHANGE button LED [23] will light.
11. Select the program number using the 0~9 buttons in the PATCH/TONE section [18].
12. Press ENTER [19].
13. Press the MODE EDIT button [12] again (the LED will go out).

[Example]

Let us select Drum Set no. 2, "Room Set" on the SC-55mkII:

1. Set the MIDI transmit channel to 10.
2. Press the MODE EDIT [12] button (indicator lights).
3. Press the CC32 button [22] (indicator lights).
4. Press the "0" key in the PATCH/TONE section [18].
5. Press ENTER [19].
6. The CC00 button LED will light.
7. Press the "0" key in the PATCH/TONE section [18].
8. Press ENTER [19].
9. The PRG CHANGE button LED will light.
10. Press the "9" key in the PATCH/TONE section [18].
11. Press ENTER [19].
12. Press the MODE EDIT [12] button again (the LED will go out).

PERFORMANCE FUNCTIONS

Using glides: Pitch Bend

Move the BENDER/MODULATION lever [26] left or right to transmit Pitch Bend messages that will alter the pitch of the notes you are playing.

* *The Pitch Bend range (maximum pitch change interval) can be set on the module or instrument you are controlling.*

Adding vibrato: Modulation (CC01)

Moving the BENDER/MODULATION lever [26] forward (away from you) will transmit Modulation messages, changing the sound in real time (usually by adding a vibrato effect).

- * *The change obtained with this message will vary depending on the settings for your sound module (the section which handles modulation), or the Tone selected.*

Sustaining notes: Damper (CC 64)

After connecting a damper pedal (DP-2/6 or FS-5U, option), you can use it to send Hold 1 messages (CC64) that cause notes sounding at that time to be sustained. If an electric organ or other normally sustained type of sound is being sounded, the notes will continue for as long as the pedal is down. Other sounds (e.g. piano) will eventually decay, albeit a lot slower than when you don't use the damper pedal. The damper pedal should be connected to the SUSTAIN SWITCH jack [28] on the rear of the unit.

Pressing the pedal will transmit an ON value (127), while releasing it will transmit an OFF value (0).

- * *The CC 64 (Hold 1) function can also be assigned to the DATA ENTRY slider, allowing you to obtain the damper effect by moving the slider.*
- * *The A-33 also features a Sustain On/Off parameter that you can use to enable or disable the transmission of Hold 1 messages for the section selected with the SELECT UPPER/LOWER [9/10] buttons.*

Changing the volume of a Part: Expression

After connecting an expression pedal (EV-5/EV-10, option), you can control the "Expression" parameter of the Upper or Lower section. Expression is a control change message that allows you to change the volume of the Part you are controlling.

Expression is a *continuous* control change parameter, which means that the volume will vary according to the value you send (0~127), as opposed to *on/off parameters* that provide only two possibilities (Sustain/Hold 1, for example). The more you depress the pedal, the higher the Expression value (and volume of the Part) will be.

- * *The A-33 also features an Expression On/Off parameter you can use to enable or disable the transmission of Expression messages for the section selected with the SELECT UPPER/LOWER [9/10] buttons.*

Enabling or disabling the transmission of certain MIDI messages

The A-33 is equipped with three data filters you can enable or disable for each section individually. These filters may come in handy in Split or Layer mode when you only wish to transmit certain MIDI messages on one MIDI channel.

Enabling/disabling the transmission of Pitch Bend/Modulation messages

Here's what to do to prevent the Upper or Lower section from sending Pitch Bend and Modulation data. Note that "Modulation" is not meant to be taken literally here since you can also assign Aftertouch to the Modulation axis of the lever (see below).

1. Press the MODE EDIT button [12] (indicator lights).
2. Press SELECT UPPER or LOWER [9/10] to select the section whose setting you wish to change.
3. Press the MIDI/PARAM button in the PATCH/TONE pad.
4. Enter the number 17 to prevent the section from sending Pitch Bend and Modulation data.
Enter the number 18 to enable the transmission of Pitch Bend and Modulation data.
5. Press the ENTER [19] button to confirm your setting.

Enabling/disabling the transmission of Hold 1 (Sustain) messages

Follow steps 1.~3. of the preceding section.

4. Enter the number 21 to prevent the selected section from sending Hold 1 (Sustain) data.
Enter the number 22 to enable the transmission of Hold 1 data.
5. Press the ENTER [19] button to confirm your setting.

Enabling/disabling the transmission of Expression messages

Follow steps 1.~3. under "Enabling/disabling the transmission of Pitch Bend/Modulation messages".

4. Enter the number 23 to prevent the selected section from sending Expression data.
Enter the number 24 to enable the transmission of Expression data.
5. Press the ENTER [19] button to confirm your setting.

Octave Shift (changing Octaves)

Using the OCTAVE [16/17] buttons (UP, DOWN), the soundable range of the keyboard can be shifted up or down one or two octaves, making it possible to access notes that lie beyond the scope of the keyboard. The Octave Shift function can be set for both sections (Upper and Lower) individually. That means you first have to press the SELECT UPPER or LOWER button [9/10] before pressing the UP or DOWN button.

Shift the Sound Range Up One Octave: OCTAVE UP

Press OCTAVE UP [17] and make sure the indicator is lit. That transposes the keyboard one octave up.

Shift the Sound Range Up Two Octaves: OCTAVE UP (twice)

Press OCTAVE UP [17] again and make sure the indicator is flashing. That transposes the keyboard two octaves up.

Shift the Sound Range Down One Octave: OCTAVE DOWN

Press OCTAVE DOWN [16] and make sure the indicator is lit. That transposes the keyboard one octave down.

Shift the Sound Range Down Two Octaves: OCTAVE DOWN (twice)

Press OCTAVE DOWN [16] again and make sure the indicator is flashing. That transposes the keyboard two octaves down.

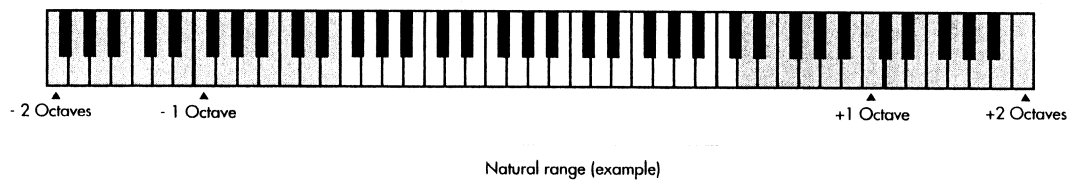

Return to the Normal Sound Range: STANDARD

Press OCTAVE UP [17] and OCTAVE DOWN [16] simultaneously.

Transposing the A-33's keyboard

Your A-33 comes with a TRANSPOSE function that you may want to use for playing songs in difficult keys.

Setting the Transpose interval

Hold down the TRANSPOSE button [15] and wait until its indicator starts flashing. Keep holding the TRANSPOSE button while you press the key assigned to the note you wish to assign to every C key.

The TRANSPOSE indicator now lights steadily to indicate that the Transpose interval has been set and is being used.

Switching the Transpose function on/off

Once the desired Transpose interval has been set, you can activate it or turn it off by pressing the TRANSPOSE [15] button. The indicator of this button will light to indicate that the Transpose interval is being used.

* *The Transpose on/off setting applies to both keyboard sections (Upper and Lower).*

CONTROLLING A SOUND MODULE WITH THE DATA ENTRY SLIDER

The following functions can be assigned to the DATA ENTRY slider:

<u>Function name</u>	<u>Description</u>
Velocity Curve	Changes the way the keyboard interprets your playing style
Reverb Send Level (CC 91)	Sets the depth of Reverb
Chorus Send Level (CC 93)	Sets the depth of Chorus
Volume (CC 07)	Sets the volume level of the Part
Panpot (CC 10)	Sets sound position (localization in the stereo sound field)
CC 00 to 127	Depends on the selected Controller Number

NOTE: Since a slider control accesses digital information, it might not produce any noticeable change in the value if moved by only a small amount. If this happens, move the slider up and down once, then set the value.

Changing the Velocity Sensitivity: Velocity Curve

Whenever a key is pressed on the instrument, the corresponding velocity value will be transmitted along with the note information. The following setting allows you to choose the sensitivity of the response to velocity (range of possible change).

Slider position: minimum

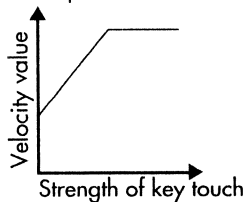

Slider position: center

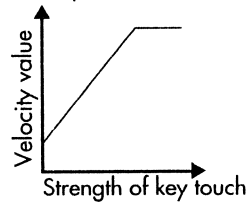

Slider position: maximum

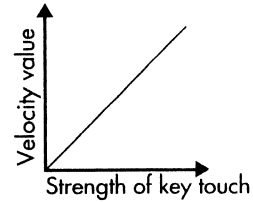

[Procedure]

1. Set the MIDI channel to match that of the Part (sound module) to be controlled.
2. Press the MODE EDIT button [12] (indicator lights).
3. Press the DATA ENT ASS button [24] (indicator lights).
4. Enter the number 128 by pressing "1", "2", and "8" in the PATCH/TONE section.

5. Confirm by pressing the ENTER button [19].
6. Press the MODE EDIT button [12] again (the LED will go out).
7. Move the DATA ENTRY slider to the position that corresponds to the Velocity Curve you wish to select. With the slider at its maximum, velocity values within the entire 1—127 range can be generated.

Changing the Reverb Depth: Reverb Send Level (CC 91)

This function allows you to set the Reverb depth for each Part.

[Procedure]

1. Set the MIDI channel to match that of the Part (sound module) to be controlled.
2. Press the MODE EDIT button [12] (indicator lights).
3. Press the DATA ENT ASS button [24] (indicator lights).
4. Enter the number “91” using the PATCH/TONE section 0~9 buttons.
5. Confirm your setting by pressing the ENTER button [19]
6. Press the MODE EDIT button [12] again (the LED will go out).
Now you can use the DATA ENTRY slider to set the value for the Reverb Send Level (Effect 1 Depth) parameter.

* *When a sound module other than a GS or General MIDI module is being used, the relevant parameter may not correctly respond to CC 91 messages.*

Changing the Chorus Depth: Chorus Send Level (CC 93)

This function allows you to set the Chorus depth for each Part.

[Procedure]

1. Set the MIDI channel to match that of the Part (sound module) to be controlled.
2. Press the MODE EDIT button [12] (indicator lights).
3. Press the DATA ENT ASS button [24] (indicator lights).
4. Enter the number “93” using the PATCH/TONE section [18] buttons.
5. Confirm your setting by pressing the ENTER button [19]
6. Press the MODE EDIT button [12] again (the LED will go out).
Now you can use the DATA ENTRY slider to set the value for the Chorus Send Level (Effect 3 Depth) parameter.

* *When a sound module other than a GS module is being used, the relevant parameter may not correctly respond to CC 93 messages.*

Changing the Volume: Volume (CC 07)

This function allows you to adjust the volume level for each Part.

[Procedure]

1. Set the MIDI channel to match that of the Part (sound module) to be controlled.
2. Press the MODE EDIT button [12] (indicator lights).
3. Press the DATA ENT ASS button [24] (indicator lights).
4. Enter the number "7" using the PATCH/TONE section [18] buttons.
5. Confirm your setting by pressing the ENTER button [19]
6. Press the MODE EDIT button [12] again (the LED will go out).

Now you can use the DATA ENTRY slider to set the value that will be transmitted for the Volume.

Setting the Sound Location: Panpot (CC 10)

Whenever you connect your GS or GM module to a stereo amplifier, this parameter allows you to set the stereo placement (L/R) of the sounds you are playing. In the case of the Drum Part (MIDI channel 10), this parameter produces a shift of the stereo placement of all drum sounds contained in the Drum Set.

[Procedure]

1. Select the Upper or Lower keyboard mode and set its transmit channel to 10.
2. Press the MODE EDIT button [12] (indicator lights).
3. Press the DATA ENT ASS button [24] (indicator lights).
4. Enter the number "10" using the PATCH/TONE section 0~9 buttons.
5. Confirm your setting by pressing the ENTER button [19]
6. Press the MODE EDIT button [12] again (the LED will go out).

Now you can use the DATA ENTRY slider to transmit the desired Panpot value. With the slider at the center, the sound will be located in the center (same volume for left and right audio channels). When pulled all the way down, the sound will be heard from the extreme left. When pushed all the way up, the sound will come from the right.

* *The Panpot parameter for the Roland MT-32 is the reverse of that for a GS sound module.*

Switching the Chorus/Reverb effect on/off

The Effect buttons (REVERB and CHORUS) allow you to switch the Reverb and/or Chorus effect of the receiving Part on or off. The Off setting actually means that the Reverb Send (CC91) or Chorus Send (CC93) level for the receiving Part or instrument is set to zero.

Press REVERB [7] to make the indicator light. In that case, the A-33 will send the CC91 value stored in the Patch Memory you selected last (see page 33 for how to store Patches). Press REVERB once more (indicator goes out) to switch off the Reverb effect for the Part that is being controlled.

Similarly, press CHORUS [8] to switch the Chorus effect on (indicator lights) or off (indicator goes dark).

Assigning Other Functions (CC 00~127) to the DATA ENTRY Slider

By assigning a control change to the DATA ENTRY slider, you can control a wide range of features on your sound module.

Any controller numbered from 0 to 95 (Continuous Controllers) can be assigned. Since the A-33 isn't equipped with a display which allows you to monitor data when transmitting it, it is not suited for operations that involve Registered and Non-Registered Parameter Numbers.

* *Certain functions are duplicated by dedicated controllers on the A-33 (modulation, expression, etc.).*

Controllers 00~95 (Continuous Controllers)

Controller Number	Control Function
0	Bank Select MSB
1	Modulation
2	Breath Controller
3	Undefined
4	Foot Controller
5	Portamento Time
6	Data Entry (Used with RPN/NRPN)
7	Main Volume
8	Balance
9	Undefined
10	Panpot
11	Expression Pedal
12	Effect Control 1
13	Effect Control 2
14—15	Undefined
16	General Purpose Controller 1
17	General Purpose Controller 2
18	General Purpose Controller 3
19	General Purpose Controller 4
20—31	Undefined
32	Bank Select LSB
33—63	LSB for controllers 1-31
64	Hold 1 (Damper)
65	Portamento
66	Sostenuto
67	Soft Pedal
68	Undefined
69	Hold 2 (Freeze)
70—79	Undefined
80	General Purpose Controller 5
81	General Purpose Controller 6
82	General Purpose Controller 7
83	General Purpose Controller 8
84—90	Undefined
91	Effect 1 (External Effect) Depth (GS/General MIDI: Reverb Send Level)
92	Effect 2 (Tremolo) Depth
93	Effect 3 (Chorus) Depth (GS: Chorus Send Level)
94	Effect 4 (Celeste) Depth
95	Effect 5 (Phaser) Depth

Controllers 96 and above (NRPN/RPN, Channel Mode Messages)	
Controller No.	Control Function
96.....	Data Increment
97.....	Data Decrement
98.....	Non-Registered Parameter Number LSB
99.....	Non-Registered Parameter Number MSB
100.....	Registered Parameter Number LSB
101.....	Registered Parameter Number MSB
102—120.....	Undefined
121—127.....	Reserved for Channel Mode Messages

[Procedure]

1. Select the Upper or Lower keyboard mode.
2. Press the MODE EDIT [12] button (indicator lights).
3. Press the DATA ENT ASS button [24] (indicator lights).
4. Select the control change by pressing the 0~9 keys in the PATCH/TONE section [18].
5. Confirm by pressing the ENTER button [19].
6. Press the MODE EDIT button [12] again (the LED will go out).
Now you can use the DATA ENTRY slider to transmit the value of the specified Controller Number.

Assigning modulation or aftertouch to the Modulation axis of the lever

The Modulation axis of the BENDER/MODULATION lever can be used for transmitting modulation (CC#1) or aftertouch data. Choose whichever is more convenient in a given situation. Note that this setting applies to both the Upper and Lower section.

The A-33 cannot transmit Channel Aftertouch messages. However, such messages can be transmitted by assigning the Channel Aftertouch function to the BENDER/MODULATION lever on the A-33.

Channel Aftertouch is a function that lets you alter notes (that are currently sounding) by applying additional pressure to the keys. On the A-33, you can obtain the same effect by assigning Aftertouch to the Modulation axis of the BENDER/MODULATION lever and pushing the lever away from you.

1. Press the MODE EDIT button [12] (indicator lights).
2. Press the MIDI/PARAM button [20].
3. Enter the number 19 to select the LEVER TO MODULATION mode. This is probably the setting you will use most of the time.
Enter the number 20 to select the LEVER TO AFTERTOUCH mode. In this case, the Modulation axis of the BENDER/MODULATION lever allows you to transmit Channel Aftertouch messages for the notes you play.

4. Press the ENTER [19] button to confirm your setting.

* *A GS sound module will not respond to Aftertouch messages while it remains set at its factory defaults. For details, refer to the owner's manual for the sound module you are using. Computer users should consult the owner's manual for their software, since it may be possible to set the response to Channel Aftertouch within the software.*

Controlling an external sequencer

Starting/stopping an external sequencer

Press the SEQUENCER START/STOP button [11] (indicator lights) to start the sequencer connected to the MIDI OUT 1 or MIDI OUT 2 jack.

Press this button once more to stop the external sequencer (indicator goes dark).

* *If the sequencer doesn't start or stop, check whether the indicator of the MIDI OUT socket the sequencer is connected to lights. Also make sure your sequencer is set to receive Start/Stop messages (see its manual).*

Changing the sequencer's playback tempo

The A-33 also allows you to modify the tempo of a sequencer connected to one of its MIDI OUT sockets. To do so, you must first assign the BPM feature to the DATA ENTRY slider:

1. Press the MODE EDIT button [12] (indicator lights).
2. Press the DATA ENT ASS button [24] (indicator lights).
3. Enter the number "129" using the PATCH/TONE section 0~9 buttons.
4. Confirm your setting by pressing the ENTER button [19]
5. Press the MODE EDIT button [12] again (the LED will go out).
Now you can use the DATA ENTRY slider to modify the tempo of the receiving sequencer.

MIDI Clock source (PB Clock EXT/INT)

A sequencer connected to the A-33 can be synchronized in one of two ways:

1. *Using the A-33's built-in MIDI Clock generator (INT).*
In this case, the tempo you set on the A-33 (see above) determines the sequencer's playback tempo. In INT mode, the A-33's Sequencer START/STOP button [11] can be used to start/stop the sequencer.
2. *Using the MIDI Clock the A-33 receives from another sequencer or drum machine connected to its MIDI IN socket (EXT).*
In this case, the A-33 will retransmit the received MIDI Clock signal via its MIDI OUT sockets. Any data generated on the A-33 itself will be merged with the

received Clock signals and transmitted to both MIDI OUT sockets along with the MIDI Clock information.

Here's how to select the INT or EXT mode:

1. Press the MODE EDIT button [12] (indicator lights).
2. Press the MIDI/PARAM button [20].
3. Enter the number 25 to select the PB CLOCK EXT mode.
Enter the number 26 to select the PB CLOCK INT mode.
4. Press the ENTER [19] button to confirm your setting.

USING THE PATCH MEMORIES

Before telling you how to store and recall your settings, there is something you need to know: your A-33 comes loaded with 32 preset Patches (see page 141 for the contents of these Patches). A "Patch" is a memory in which you can store your own settings. You may have noticed the names of the 16 buttons in the PATCH/TONE keypad [18] (Piano, Chr. Perc., etc.). These names refer to the contents of the corresponding *preset* Patch memories, or rather to the effect the selection of that Patch memory has when the A-33 is connected to a GS compatible module. Thus, button number 12 will call up a synthesizer pad sound, for example.

Each preset Patch also contains a number of other useful settings, of course (see below).

Storing settings in a Patch memory

After setting all parameters to your liking, you may wish to store them in one of the A-33's 32 Patch Memories.

[Procedure]

1. Press and hold the WRITE button [25].
2. Press the PATCH A or B button [13/14] to select the bank in which you wish to store your settings.
3. Press the button (1~16) in the PATCH/TONE section [18] corresponding to the Patch memory where you wish to store the current settings.

The following settings will be stored in that Patch Memory:

- DATA ENTRY slider assignment
- Transpose On/Off and Transpose Value
- BPM value (Speed) and Ext/Int setting
- CC0 Value, CC32 Value, Program Change value for the Upper section (Selected sound)
- CC0 Value, CC32 Value, Program Change value for the Lower section (Selected sound)
- (*) Upper CC91 Value (Reverb Depth)
- (*) Upper CC93 Value (Chorus Depth)
- (*) Lower CC91 Value (Reverb Depth)
- (*) Lower CC93 Value (Chorus Depth)
- (*) Upper CC07 Value (Volume)
- (*) Lower CC07 Value (Volume)
- Upper MIDI channel
- Lower MIDI channel
- MIDI Out 1 On/Off
- MIDI Out 2 On/Off
- Upper Section On/Off
- Lower Section On/Off
- Split On/Off
- Upper Octave
- Lower Octave
- Upper CC Filter
- Lower CC Filter
- Modulation Lever assignment (Modulation/ After Touch)
- P BEND MOD on/off
- Lever to Modulation/ Aftertouch
- Sustain on/off
- Expression on/off

(*) The values of Control Change messages (CC) marked with “(*)” are stored in the A-33’s Patches according to an internal 8-unit resolution.

Example: a value between 0 and 7 of a Control Change message marked with “(*)” will be stored as “7”, a value between 8 and 15 as “15”, ..., and a value between 120 and 127 as “127”.

To set the Reverb and/or Chorus depth to “0”, press the corresponding button on the front panel. (The button’s status is stored in the Patches.)

How to recall a Patch memory setting

The A-33 provides 32 User Patch memories divided in two banks A and B of 16 Patches each.

[Procedure]

1. Make sure one of the two PATCH indicators, A or B [13/14] is lit.
If not, press one of these buttons (the indicator lights).
2. Select the Patch by pressing one of the buttons in the PATCH/TONE section [18].

Note: Changing the bank using the PATCH A or PATCH B buttons will automatically recall the current Patch in the selected bank.

Default Settings

At Power-On, the A-33 automatically selects Patch A-1.

The table on page 141 shows the contents of 32 Preset Patches.

Restore Factory settings

To reset the A-33 to the factory settings, power on the instrument while pressing WRITE [25] button.

During this operation, all the panel indicators will flash. This operation takes about 30 seconds.

* *You may wish to transmit your own settings to an external sequencer before restoring the factory settings.*

TRANSMITTING THE A-33'S SETTINGS VIA MIDI (DATA DUMP)

The contents of the A-33's Patch memories can be stored using an external sequencer, computer or MIDI data filer, which may come in handy for making backups before performing live or to expand the A-33's potential.

1. Press MODE EDIT [12] (indicator lights).
2. Press the MIDI/PARAM button [20] (indicator lights).
3. Now press the "2" and "8" buttons in the PATCH/TONE section to select the 28 DATA DUMP function.
4. Start the recording on your sequencer.
5. Press ENTER [19] to start the transmission of the Bulk Dump.

BATTERY LIFE CHECK

The A-33 can also be battery-operated. The current battery status can be checked with the following procedure:

[Procedure]

1. Press the MODE EDIT button [12] (indicator lights).
2. Enter the number "27" using the PATCH/TONE section.
3. Confirm by pressing the ENTER button [19] and keep it pressed.
The PATCH/TONE indicators will light to indicate the approximate remaining battery power. Each LED represents about two hours.
4. Release the ENTER [19] button after checking the remaining battery power.

TROUBLESHOOTING

- Q: The unit cannot be switched on or it doesn't work at all.
A: Check the batteries.
A: Check if you are using the correct AC adaptor. (Use only the specified adaptor – using any other adaptor may result in damage, malfunction or electric shock.)
- Q: The sound module does not respond to the movements of the DATA ENTRY slider.
A: Check if the correct function is assigned to the DATA ENTRY slider. Also note that the module sometimes does not respond if the slider is moved only slightly. If you are unsure, pull the slider all the way down first and then set it to the desired position.
- Q: The external module or sequencer does not respond to your playing.
A: You probably forgot to enable the MIDI OUT socket the external device is connected to. Press the corresponding MIDI OUT button [2/3] (indicator must light).
- Q: Using the Modulation lever does not yield the expected result.
A: You probably assigned Aftertouch to the Modulation axis. Select the LEVER TO MODULATION mode (MIDI Parameter 19).
- Q: The module or Part does not respond to Hold 1 (Sustain), Expression, or Pitch Bend/Modulation data.
A: You probably enabled the filter of that data type so that the A-33 doesn't transmit Hold 1, Expression, or Pitch Bend & Modulation data. Disable the filter in question: select "On" for P BEND MOD (MIDI Parameter 18), Sustain (22) or Expression (24).
- Q: The sound you requested cannot be selected.
A: Some GS modules, such as the Sound Canvas series, have a switch that allows you to turn on or off the reception of Program Change messages and/or Bank Select messages. Be sure this switch is turned ON.
A: Could the sound module have received a GM System On message (the message that tells a module to function as a General MIDI sound module) before you sent Bank Select messages? Since Bank Selects are not recognized by the General MIDI System Level 1 specifications, the module will ignore them if it is currently behaving as a General MIDI device. To correct this situation, send a GS Reset message (which retrieves the GS default settings), or simply switch the

module off, then on again.

* *The A-33 cannot transmit GS Reset messages.*

A: When specifying the change in sound, did you supply the complete set of values (values for CC 00/CC 32 and Program Number)? When a change in sound is made using the A-33, the complete set of three values (value for CC 00 and CC 32, then the Program number) is transmitted, even if only the Program Number has been specified. Note also that the values for a sound selection remain stored in memory until the next sound has been successfully selected. So, if even one out of the complete set of three values is mistakenly not supplied, part of the previous values could be sent along with the newly specified ones. As a result, you might not obtain the sound you hoped for.

A: Does your computer music application use Program Numbers 0 to 127 for sound selection? Since the A-33 uses numbers 1 to 128, you may need to add one to the number being selected to obtain the correct sound.

Q: The GS module does not respond to Aftertouch messages.

A: A GS sound module will not respond to Aftertouch messages unless you change its default setting. Therefore, you need to set the Aftertouch parameters using Exclusive messages. (Refer to the MIDI Implementation for the sound module in question.) When using a computer-based system, you may be able to easily make the required settings using the software.

SPECIFICATIONS

Keyboard

76 keys (velocity sensitive)

MIDI Control

MIDI Channels (1 to 16)

Octave Shift (Up 2 Octaves, Down 2 Octaves, Standard)

Bender/Modulation/Aftertouch Lever

Data Entry Slider

Controller Numbers 00/32 (GS Variation selection)

Reverb Send Level

Chorus Send Level

Volume

Panpot

Others (Controller Numbers 00 to 127)

Velocity Curve (H, M, L)

BPM (F8 Clock Rate)

Rear Panel

Power Switch, Sustain Switch jack, Expression jack, AC Adaptor jack, MIDI (IN/OUT1/OUT2/THRU)

Power Supply

DC 9V: AC adaptor (option); Dry Batteries (R6 [AA] type)

Current Draw

50mA

Dimensions

1195 (W) x 270 (D) x 113 (H) mm

47-3/8 x 10-5/8 x 4-4/8 inches

Weight

7.7 kg / 17 lbs

Accessories

Owner's Manual, MIDI Cable

Options

AC Adaptor (BOSS ACA series)

AC 117 V: ACA 120

AC 220 V: ACA 220

AC 240 V: ACA 240

Footswitch: Roland DP-2, DP-6 or Boss FS-5U

Expression pedal: Roland EV-5, EV-10, or Boss FV-300L

** In the interest of product development, the specifications and/or appearance of this unit are subject to change without prior notice.*

A-33 FACTORY PATCH SETTINGS

Patch ①

Common Parameter.

DATA ENTRY: CC-07	TRANSPOSE: +1
BPM: 120	CLOCK: INT
EXPR. LEVER TO: MOD	SPLIT: Off-E3/52

Upper Section

MIDI Channel: 1	On/Off: On	
CC00: 0	CC32: 0	PG: 1
Chorus: 31-Off	Reverb: 71-On	Volume: 127
Pitch Bender: Off	Sustain: On	Octave: 0

Lower Section

MIDI Channel: 2	On/Off: Off	
CC00: 0	CC32: 0	PG: 33
Chorus: 31-Off	Reverb: 71-On	Volume: 127
Pitch Bender: On	Sustain: Off	Octave: 0

Patch ②

Common Parameter.

DATA ENTRY: CC-07	TRANSPOSE: +1
BPM: 120	CLOCK: INT
EXPR. LEVER TO: MOD	SPLIT: Off-E3/52

Upper Section

MIDI Channel: 1	On/Off: On	
CC00: 0	CC32: 0	PG: 12
Chorus: 39-On	Reverb: 87-On	Volume: 127
Pitch Bender: Off	Sustain: On	Octave: 0

Lower Section

MIDI Channel: 2	On/Off: Off	
CC00: 0	CC32: 0	PG: 33
Chorus: 31-Off	Reverb: 71-On	Volume: 127
Pitch Bender: On	Sustain: Off	Octave: 0

Patch ③

Common Parameter.

DATA ENTRY: CC-07	TRANSPOSE: +1
BPM: 120	CLOCK: INT
EXPR. LEVER TO: MOD	SPLIT: Off-E3/52

Upper Section

MIDI Channel: 1	On/Off: On	
CC00: 0	CC32: 0	PG: 19
Chorus: 39-On	Reverb: 87-On	Volume: 127
Pitch Bender: Off	Sustain: On	Octave: 0

Lower Section

MIDI Channel: 2	On/Off: Off	
CC00: 0	CC32: 0	PG: 31
Chorus: 71-On	Reverb: 127-On	Volume: 111
Pitch Bender: On	Sustain: Off	Octave: +1

Patch ④

Common Parameter.

DATA ENTRY: CC-07	TRANSPOSE: +1
BPM: 120	CLOCK: INT
EXPR. LEVER TO: MOD	SPLIT: Off-E3/52

Upper Section

MIDI Channel: 1	On/Off: On	
CC00: 0	CC32: 0	PG: 25
Chorus: 23-On	Reverb: 119-On	Volume: 127
Pitch Bender: On	Sustain: On	Octave: -1

Lower Section

MIDI Channel: 2	On/Off: Off	
CC00: 0	CC32: 0	PG: 55
Chorus: 47-On	Reverb: 127-On	Volume: 111
Pitch Bender: On	Sustain: On	Octave: -1

Patch ⑤

Common Parameter.

DATA ENTRY: CC-07	TRANSPOSE: +1
BPM: 120	CLOCK: INT
EXPR. LEVER TO: MOD	SPLIT: Off-E3/52

Upper Section

MIDI Channel: 1	On/Off: On	
CC00: 0	CC32: 0	PG: 34
Chorus: 23-On	Reverb: 87-On	Volume: 127
Pitch Bender: On	Sustain: On	Octave: -1

Lower Section

MIDI Channel: 2	On/Off: Off	
CC00: 0	CC32: 0	PG: 40
Chorus: 47-On	Reverb: 79-On	Volume: 103
Pitch Bender: On	Sustain: On	Octave: 0

Patch ⑥

Common Parameter.

DATA ENTRY: CC-07	TRANSPOSE: +1
BPM: 120	CLOCK: INT
EXPR. LEVER TO: MOD	SPLIT: Off-E3/52

Upper Section

MIDI Channel: 1	On/Off: On	
CC00: 0	CC32: 0	PG: 41
Chorus: 31-Off	Reverb: 127-On	Volume: 127
Pitch Bender: On	Sustain: Off	Octave: 0

Lower Section

MIDI Channel: 2	On/Off: Off	
CC00: 8	CC32: 0	PG: 7
Chorus: 23-Off	Reverb: 55-On	Volume: 127
Pitch Bender: Off	Sustain: On	Octave: +1

Patch ⑦

Common Parameter.

DATA ENTRY: CC-07	TRANSPOSE: +1
BPM: 120	CLOCK: INT
EXPR. LEVER TO: MOD	SPLIT: Off-E3/52

Upper Section

MIDI Channel: 1	On/Off: On	
CC00: 0	CC32: 0	PG: 50
Chorus: 39-On	Reverb:127-On	Volume: 103
Pitch Bender: On	Sustain: On	Octave: -1

Lower Section

MIDI Channel: 2	On/Off: Off	
CC00: 0	CC32: 0	PG: 4
Chorus: 71-On	Reverb:127-On	Volume: 127
Pitch Bender: On	Sustain: On	Octave: -1

Patch ⑧

Common Parameter.

DATA ENTRY: CC-07	TRANSPOSE: +1
BPM: 120	CLOCK: INT
EXPR. LEVER TO: MOD	SPLIT: Off-E3/52

Upper Section

MIDI Channel: 1	On/Off: On	
CC00: 0	CC32: 0	PG: 60
Chorus: 23-Off	Reverb:127-On	Volume: 127
Pitch Bender: On	Sustain: Off	Octave: -1

Lower Section

MIDI Channel: 2	On/Off: Off	
CC00: 8	CC32: 0	PG: 5
Chorus: 71- On	Reverb:71-On	Volume: 127
Pitch Bender: Off	Sustain: On	Octave: 0

Patch ⑨

Common Parameter.

DATA ENTRY: CC-07	TRANSPOSE: +1
BPM: 120	CLOCK: INT
EXPR. LEVER TO: MOD	SPLIT: Off-E3/52

Upper Section

MIDI Channel: 1	On/Off: On	
CC00: 0	CC32: 0	PG: 69
Chorus: 31-Off	Reverb: 127-On	Volume: 127
Pitch Bender: On	Sustain: Off	Octave: 0

Lower Section

MIDI Channel: 2	On/Off: Off	
CC00: 8	CC32: 0	PG: 7
Chorus: 23-Off	Reverb:55-On	Volume: 127
Pitch Bender: Off	Sustain: On	Octave: +1

Patch ⑩

Common Parameter.

DATA ENTRY: CC-07	TRANSPOSE: +1
BPM: 120	CLOCK: INT
EXPR. LEVER TO: MOD	SPLIT: Off-E3/52

Upper Section

MIDI Channel: 1	On/Off: On	
CC00: 0	CC32: 0	PG: 76
Chorus: 31-Off	Reverb:127-On	Volume: 127
Pitch Bender: On	Sustain: Off	Octave: 0

Lower Section

MIDI Channel: 2	On/Off: Off	
CC00: 0	CC32: 0	PG: 92
Chorus: 23-On	Reverb: 55-On	Volume: 127
Pitch Bender: Off	Sustain: On	Octave: +1

Patch ⑪

Common Parameter.

DATA ENTRY: CC-07	TRANSPOSE: +1
BPM: 120	CLOCK: INT
EXPR. LEVER TO: MOD	SPLIT: Off-E3/52

Upper Section

MIDI Channel: 1	On/Off: On	
CC00: 0	CC32: 0	PG: 81
Chorus: 39-On	Reverb:127-On	Volume: 127
Pitch Bender: On	Sustain: On	Octave: 0

Lower Section

MIDI Channel: 2	On/Off: Off	
CC00: 0	CC32: 0	PG: 88
Chorus: 71-Off	Reverb:127-On	Volume: 103
Pitch Bender: On	Sustain: On	Octave: -1

Patch ⑫

Common Parameter.

DATA ENTRY: CC-07	TRANSPOSE: +1
BPM: 120	CLOCK: INT
EXPR. LEVER TO: MOD	SPLIT: Off-E3/52

Upper Section

MIDI Channel: 1	On/Off: On	
CC00: 0	CC32: 0	PG: 95
Chorus: 39-On	Reverb:127-On	Volume: 127
Pitch Bender: On	Sustain: On	Octave: 0

Lower Section

MIDI Channel: 2	On/Off: Off	
CC00: 0	CC32: 0	PG: 101
Chorus: 71-On	Reverb:127-On	Volume: 71
Pitch Bender: On	Sustain: On	Octave: 0

Patch 13**Common Parameter.**

DATA ENTRY: CC-07	TRANSPOSE: +1
BPM: 120	CLOCK: INT
EXPR. LEVER TO: MOD	SPLIT: Off-E3/52

Upper Section

MIDI Channel: 1	On/Off: On	
CC00: 0	CC32: 0	PG: 97
Chorus: 39-On	Reverb:127-On	Volume: 127
Pitch Bender: On	Sustain: On	Octave: -1

Lower Section

MIDI Channel: 2	On/Off: Off	
CC00: 0	CC32: 0	PG: 10
Chorus: 71-On	Reverb:127-On	Volume: 63
Pitch Bender: On	Sustain: On	Octave: 0

Patch 14**Common Parameter.**

DATA ENTRY: CC-07	TRANSPOSE: +1
BPM: 120	CLOCK: INT
EXPR. LEVER TO: MOD	SPLIT: Off-B3/59

Upper Section

MIDI Channel: 1	On/Off: On	
CC00: 0	CC32: 0	PG: 105
Chorus: 31-Off	Reverb:71-On	Volume: 127
Pitch Bender: On	Sustain: Off	Octave: -1

Lower Section

MIDI Channel: 2	On/Off: Off	
CC00: 0	CC32: 0	PG: 104
Chorus: 31-Off	Reverb:71-On	Volume: 127
Pitch Bender: Off	Sustain: On	Octave: +1

Patch 15**Common Parameter.**

DATA ENTRY: CC-07	TRANSPOSE: +1
BPM: 120	CLOCK: INT
EXPR. LEVER TO: MOD	SPLIT: On-B3/59

Upper Section

MIDI Channel: 1	On/Off: On	
CC00: 0	CC32: 0	PG: 115
Chorus: 31-Off	Reverb:87-On	Volume: 127
Pitch Bender: On	Sustain: On	Octave: -1

Lower Section

MIDI Channel: 2	On/Off: On	
CC00: 0	CC32: 0	PG: 13
Chorus: 31-Off	Reverb:127-On	Volume: 127
Pitch Bender: On	Sustain: On	Octave: +1

Patch 16**Common Parameter.**

DATA ENTRY: CC-07	TRANSPOSE: +1
BPM: 120	CLOCK: INT
EXPR. LEVER TO: MOD	SPLIT: On-B3/59

Upper Section

MIDI Channel: 1	On/Off: On	
CC00: 1	CC32: 0	PG: 123
Chorus: 87-On	Reverb:127-On	Volume: 127
Pitch Bender: On	Sustain: On	Octave: 0

Lower Section

MIDI Channel: 2	On/Off: On	
CC00: 2	CC32: 0	PG: 123
Chorus: 87-Off	Reverb:127-On	Volume: 127
Pitch Bender: On	Sustain: On	Octave: 0

Patch 17**Common Parameter.**

DATA ENTRY: CC-07	TRANSPOSE: +1
BPM: 120	CLOCK: INT
EXPR. LEVER TO: MOD	SPLIT: Off-E3/52

Upper Section

MIDI Channel: 1	On/Off: On	
CC00: 0	CC32: 0	PG: 6
Chorus: 127-On	Reverb:127-On	Volume: 127
Pitch Bender: Off	Sustain: On	Octave: 0

Lower Section

MIDI Channel: 2	On/Off: Off	
CC00: 0	CC32: 0	PG: 36
Chorus: 95-On	Reverb:127-On	Volume: 103
Pitch Bender: On	Sustain: Off	Octave: 0

Patch 18**Common Parameter.**

DATA ENTRY: CC-07	TRANSPOSE: +1
BPM: 120	CLOCK: INT
EXPR. LEVER TO: MOD	SPLIT: Off-E3/52

Upper Section

MIDI Channel: 1	On/Off: On	
CC00: 0	CC32: 0	PG: 13
Chorus: 39-Off	Reverb:87-On	Volume: 127
Pitch Bender: Off	Sustain: On	Octave: 0

Lower Section

MIDI Channel: 2	On/Off: Off	
CC00: 0	CC32: 0	PG: 33
Chorus: 31-On	Reverb:71-Off	Volume: 127
Pitch Bender: Off	Sustain: Off	Octave: 0

Patch 19

Common Parameter.

DATA ENTRY: CC-07 TRANSPOSE: +1
BPM: 120 CLOCK: INT
EXPR. LEVER TO: MOD SPLIT: Off-E3/52

Upper Section

MIDI Channel: 1 On/Off: On
CC00: 0 CC32: 0 PG: 20
Chorus: 63-On Reverb:127-On Volume: 127
Pitch Bender: On Sustain: On Octave: 0

Lower Section

MIDI Channel: 2 On/Off: Off
CC00: 0 CC32: 0 PG: 53
Chorus: 47-On Reverb:127-On Volume: 111
Pitch Bender: On Sustain: On Octave: 0

Patch 20

Common Parameter.

DATA ENTRY: CC-07 TRANSPOSE: +1
BPM: 120 CLOCK: INT
EXPR. LEVER TO: MOD SPLIT: Off-E3/52

Upper Section

MIDI Channel: 1 On/Off: On
CC00: 0 CC32: 0 PG: 30
Chorus: 63-On Reverb:127-On Volume: 127
Pitch Bender: On Sustain: On Octave: -1

Lower Section

MIDI Channel: 2 On/Off: Off
CC00: 0 CC32: 0 PG: 82
Chorus: 87-On Reverb:127-On Volume: 87
Pitch Bender: On Sustain: On Octave: -1

Patch 21

Common Parameter.

DATA ENTRY: CC-07 TRANSPOSE: +1
BPM: 120 CLOCK: INT
EXPR. LEVER TO: MOD SPLIT: Off-E3/52

Upper Section

MIDI Channel: 1 On/Off: On
CC00: 0 CC32: 0 PG: 37
Chorus: 23-On Reverb:71-On Volume: 127
Pitch Bender: On Sustain: On Octave: -1

Lower Section

MIDI Channel: 2 On/Off: Off
CC00: 8 CC32: 0 PG: 29
Chorus: 63-On Reverb:127-On Volume: 103
Pitch Bender: On Sustain: On Octave: 0

Patch 22

Common Parameter.

DATA ENTRY: CC-07 TRANSPOSE: +1
BPM: 120 CLOCK: INT
EXPR. LEVER TO: MOD SPLIT: Off-E3/52

Upper Section

MIDI Channel: 1 On/Off: On
CC00: 0 CC32: 0 PG: 45
Chorus: 31-Off Reverb:127-On Volume: 127
Pitch Bender: On Sustain: On Octave: 0

Lower Section

MIDI Channel: 2 On/Off: Off
CC00: 0 CC32: 0 PG: 47
Chorus: 23-Off Reverb:127-On Volume: 127
Pitch Bender: On Sustain: On Octave: 0

Patch 23

Common Parameter.

DATA ENTRY: CC-07 TRANSPOSE: +1
BPM: 120 CLOCK: INT
EXPR. LEVER TO: MOD SPLIT: Off-E3/52

Upper Section

MIDI Channel: 1 On/Off: On
CC00: 0 CC32: 0 PG: 55
Chorus: 39-On Reverb:127-On Volume: 127
Pitch Bender: On Sustain: On Octave: -1

Lower Section

MIDI Channel: 2 On/Off: Off
CC00: 0 CC32: 0 PG: 99
Chorus: 71-On Reverb:127-On Volume: 71
Pitch Bender: On Sustain: On Octave: +1

Patch 24

Common Parameter.

DATA ENTRY: CC-07 TRANSPOSE: +1
BPM: 120 CLOCK: INT
EXPR. LEVER TO: MOD SPLIT: Off-E3/52

Upper Section

MIDI Channel: 1 On/Off: On
CC00: 0 CC32: 0 PG: 62
Chorus: 31-On Reverb:127-On Volume: 127
Pitch Bender: On Sustain: On Octave: 0

Lower Section

MIDI Channel: 2 On/Off: Off
CC00: 0 CC32: 0 PG: 82
Chorus: 63-On Reverb:127-On Volume: 103
Pitch Bender: On Sustain: On Octave: -1

Patch 25

Common Parameter.

DATA ENTRY: CC-07	TRANSPOSE: +1
BPM: 120	CLOCK: INT
EXPR. LEVER TO: MOD	SPLIT: Off-E3/52

Upper Section

MIDI Channel: 1	On/Off: On	
CC00: 0	CC32: 0	PG: 66
Chorus: 31-Off	Reverb:127-On	Volume: 127
Pitch Bender: On	Sustain: Off	Octave: -1

Lower Section

MIDI Channel: 2	On/Off: Off	
CC00: 8	CC32: 0	PG: 5
Chorus: 127-On	Reverb:127-On	Volume: 127
Pitch Bender: Off	Sustain: On	Octave: 0

Patch 26

Common Parameter.

DATA ENTRY: CC-07	TRANSPOSE: +1
BPM: 120	CLOCK: INT
EXPR. LEVER TO: MOD	SPLIT: Off-E3/52

Upper Section

MIDI Channel: 1	On/Off: On	
CC00: 0	CC32: 0	PG: 78
Chorus: 31-Off	Reverb:127-On	Volume: 127
Pitch Bender: On	Sustain: Off	Octave: 0

Lower Section

MIDI Channel: 2	On/Off: Off	
CC00: 0	CC32: 0	PG: 108
Chorus: 23-Off	Reverb:55-On	Volume: 127
Pitch Bender: Off	Sustain: On	Octave: +1

Patch 27

Common Parameter.

DATA ENTRY: CC-07	TRANSPOSE: +1
BPM: 120	CLOCK: INT
EXPR. LEVER TO: MOD	SPLIT: Off-E3/52

Upper Section

MIDI Channel: 1	On/Off: On	
CC00: 0	CC32: 0	PG: 86
Chorus: 39-On	Reverb:127-On	Volume: 127
Pitch Bender: On	Sustain: On	Octave: 0

Lower Section

MIDI Channel: 2	On/Off: Off	
CC00: 0	CC32: 0	PG: 114
Chorus: 39-On	Reverb:127-On	Volume: 63
Pitch Bender: On	Sustain: On	Octave: +1

Patch 28

Common Parameter.

DATA ENTRY: CC-07	TRANSPOSE: +1
BPM: 120	CLOCK: INT
EXPR. LEVER TO: MOD	SPLIT: Off-E3/52

Upper Section

MIDI Channel: 1	On/Off: On	
CC00: 0	CC32: 0	PG: 96
Chorus: 127-On	Reverb:39-On	Volume: 127
Pitch Bender: On	Sustain: On	Octave: -1

Lower Section

MIDI Channel: 2	On/Off: Off	
CC00: 0	CC32: 0	PG: 102
Chorus: 127-On	Reverb:71-On	Volume: 127
Pitch Bender: On	Sustain: On	Octave: 0

Patch 29

Common Parameter.

DATA ENTRY: CC-07	TRANSPOSE: +1
BPM: 120	CLOCK: INT
EXPR. LEVER TO: MOD	SPLIT: Off-E3/52

Upper Section

MIDI Channel: 1	On/Off: On	
CC00: 0	CC32: 0	PG: 103
Chorus: 39-On	Reverb:127-On	Volume: 127
Pitch Bender: On	Sustain: On	Octave: -1

Lower Section

MIDI Channel: 2	On/Off: Off	
CC00: 0	CC32: 0	PG: 116
Chorus: 71-On	Reverb:127-On	Volume: 55
Pitch Bender: On	Sustain: On	Octave: +1

Patch 30

Common Parameter.

DATA ENTRY: CC-07	TRANSPOSE: +1
BPM: 120	CLOCK: INT
EXPR. LEVER TO: MOD	SPLIT: On-B3/59

Upper Section

MIDI Channel: 1	On/Off: On	
CC00: 0	CC32: 0	PG: 110
Chorus: 31-On	Reverb:71-On	Volume: 127
Pitch Bender: On	Sustain: On	Octave: -1

Lower Section

MIDI Channel: 10	On/Off: On	
CC00: 0	CC32: 0	PG: 49
Chorus: 31-Off	Reverb:71-On	Volume: 127
Pitch Bender: Off	Sustain: Off	Octave: 0

Patch 31**Common Parameter.**

DATA ENTRY: CC-07	TRANSCOPE: +1
BPM: 120	CLOCK: INT
EXPR. LEVER TO: MOD	SPLIT: On-B3/59

Upper Section

MIDI Channel: 1	On/Off: On	
CC00: 0	CC32: 0	PG: 119
Chorus: 87-Off	Reverb:127-On	Volume: 127
Pitch Bender: On	Sustain: Off	Octave: -1

Lower Section

MIDI Channel: 10	On/Off: On	
CC00: 0	CC32: 0	PG: 17
Chorus: 87-Off	Reverb:127-On	Volume: 127
Pitch Bender: Off	Sustain: Off	Octave: 0

Patch 30**Common Parameter.**

DATA ENTRY: CC-07	TRANSCOPE: +1
BPM: 120	CLOCK: INT
EXPR. LEVER TO: MOD	SPLIT: On-B3/59

Upper Section

MIDI Channel: 1	On/Off: On	
CC00: 9	CC32: 0	PG: 126
Chorus: 87-On	Reverb:127-On	Volume: 127
Pitch Bender: On	Sustain: Off	Octave: 0

Lower Section

MIDI Channel: 2	On/Off: On	
CC00: 8	CC32: 0	PG: 126
Chorus: 87-On	Reverb:127-On	Volume: 127
Pitch Bender: On	Sustain: On	Octave: 0

EXAMPLES

Patch		
<i>Common Parameter.</i>		
DATA ENTRY:	TRANPOSE:	
BPM:	CLOCK:	
EXPR. LEVER TO:	SPLIT:	
<i>Upper Section</i>		
MIDI Channel:	On/Off:	
CC00:	CC32:	PG:
Chorus:	Reverb:	Volume:
Pitch Bender:	Sustain:	Octave:
<i>Lower Section</i>		
MIDI Channel:	On/Off:	
CC00:	CC32:	PG:
Chorus:	Reverb:	Volume:
Pitch Bender:	Sustain:	Octave:

Patch		
<i>Common Parameter.</i>		
DATA ENTRY:	TRANPOSE:	
BPM:	CLOCK:	
EXPR. LEVER TO:	SPLIT:	
<i>Upper Section</i>		
MIDI Channel:	On/Off:	
CC00:	CC32:	PG:
Chorus:	Reverb:	Volume:
Pitch Bender:	Sustain:	Octave:
<i>Lower Section</i>		
MIDI Channel:	On/Off:	
CC00:	CC32:	PG:
Chorus:	Reverb:	Volume:
Pitch Bender:	Sustain:	Octave:

Patch		
<i>Common Parameter.</i>		
DATA ENTRY:	TRANPOSE:	
BPM:	CLOCK:	
EXPR. LEVER TO:	SPLIT:	
<i>Upper Section</i>		
MIDI Channel:	On/Off:	
CC00:	CC32:	PG:
Chorus:	Reverb:	Volume:
Pitch Bender:	Sustain:	Octave:
<i>Lower Section</i>		
MIDI Channel:	On/Off:	
CC00:	CC32:	PG:
Chorus:	Reverb:	Volume:
Pitch Bender:	Sustain:	Octave:

Patch		
<i>Common Parameter.</i>		
DATA ENTRY:	TRANPOSE:	
BPM:	CLOCK:	
EXPR. LEVER TO:	SPLIT:	
<i>Upper Section</i>		
MIDI Channel:	On/Off:	
CC00:	CC32:	PG:
Chorus:	Reverb:	Volume:
Pitch Bender:	Sustain:	Octave:
<i>Lower Section</i>		
MIDI Channel:	On/Off:	
CC00:	CC32:	PG:
Chorus:	Reverb:	Volume:
Pitch Bender:	Sustain:	Octave:

Patch		
<i>Common Parameter.</i>		
DATA ENTRY:	TRANPOSE:	
BPM:	CLOCK:	
EXPR. LEVER TO:	SPLIT:	
<i>Upper Section</i>		
MIDI Channel:	On/Off:	
CC00:	CC32:	PG:
Chorus:	Reverb:	Volume:
Pitch Bender:	Sustain:	Octave:
<i>Lower Section</i>		
MIDI Channel:	On/Off:	
CC00:	CC32:	PG:
Chorus:	Reverb:	Volume:
Pitch Bender:	Sustain:	Octave:

Patch		
<i>Common Parameter.</i>		
DATA ENTRY:	TRANPOSE:	
BPM:	CLOCK:	
EXPR. LEVER TO:	SPLIT:	
<i>Upper Section</i>		
MIDI Channel:	On/Off:	
CC00:	CC32:	PG:
Chorus:	Reverb:	Volume:
Pitch Bender:	Sustain:	Octave:
<i>Lower Section</i>		
MIDI Channel:	On/Off:	
CC00:	CC32:	PG:
Chorus:	Reverb:	Volume:
Pitch Bender:	Sustain:	Octave:

Patch		
<i>Common Parameter.</i>		
DATA ENTRY:	TRANSCOPE:	
BPM:	CLOCK:	
EXPR. LEVER TO:	SPLIT:	
<i>Upper Section</i>		
MIDI Channel:	On/Off:	
CC00:	CC32:	PG:
Chorus:	Reverb:	Volume:
Pitch Bender:	Sustain:	Octave:
<i>Lower Section</i>		
MIDI Channel:	On/Off:	
CC00:	CC32:	PG:
Chorus:	Reverb:	Volume:
Pitch Bender:	Sustain:	Octave:

Patch		
<i>Common Parameter.</i>		
DATA ENTRY:	TRANSCOPE:	
BPM:	CLOCK:	
EXPR. LEVER TO:	SPLIT:	
<i>Upper Section</i>		
MIDI Channel:	On/Off:	
CC00:	CC32:	PG:
Chorus:	Reverb:	Volume:
Pitch Bender:	Sustain:	Octave:
<i>Lower Section</i>		
MIDI Channel:	On/Off:	
CC00:	CC32:	PG:
Chorus:	Reverb:	Volume:
Pitch Bender:	Sustain:	Octave:

Patch		
<i>Common Parameter.</i>		
DATA ENTRY:	TRANSCOPE:	
BPM:	CLOCK:	
EXPR. LEVER TO:	SPLIT:	
<i>Upper Section</i>		
MIDI Channel:	On/Off:	
CC00:	CC32:	PG:
Chorus:	Reverb:	Volume:
Pitch Bender:	Sustain:	Octave:
<i>Lower Section</i>		
MIDI Channel:	On/Off:	
CC00:	CC32:	PG:
Chorus:	Reverb:	Volume:
Pitch Bender:	Sustain:	Octave:

Patch		
<i>Common Parameter.</i>		
DATA ENTRY:	TRANSCOPE:	
BPM:	CLOCK:	
EXPR. LEVER TO:	SPLIT:	
<i>Upper Section</i>		
MIDI Channel:	On/Off:	
CC00:	CC32:	PG:
Chorus:	Reverb:	Volume:
Pitch Bender:	Sustain:	Octave:
<i>Lower Section</i>		
MIDI Channel:	On/Off:	
CC00:	CC32:	PG:
Chorus:	Reverb:	Volume:
Pitch Bender:	Sustain:	Octave:

Patch		
<i>Common Parameter.</i>		
DATA ENTRY:	TRANSCOPE:	
BPM:	CLOCK:	
EXPR. LEVER TO:	SPLIT:	
<i>Upper Section</i>		
MIDI Channel:	On/Off:	
CC00:	CC32:	PG:
Chorus:	Reverb:	Volume:
Pitch Bender:	Sustain:	Octave:
<i>Lower Section</i>		
MIDI Channel:	On/Off:	
CC00:	CC32:	PG:
Chorus:	Reverb:	Volume:
Pitch Bender:	Sustain:	Octave:

Patch		
<i>Common Parameter.</i>		
DATA ENTRY:	TRANSCOPE:	
BPM:	CLOCK:	
EXPR. LEVER TO:	SPLIT:	
<i>Upper Section</i>		
MIDI Channel:	On/Off:	
CC00:	CC32:	PG:
Chorus:	Reverb:	Volume:
Pitch Bender:	Sustain:	Octave:
<i>Lower Section</i>		
MIDI Channel:	On/Off:	
CC00:	CC32:	PG:
Chorus:	Reverb:	Volume:
Pitch Bender:	Sustain:	Octave:

MIDI IMPLEMENTATION CHART

MODEL A-33
(MIDI Keyboard Controller)

Date: January 1996
Version: 1.00

FUNCTION	TRANSMITTED	RECOGNIZED	REMARKS
Basic Channel Default Changed	1 1-16, OFF	1-16 1-16, OFF	(a) 1 = Upper 2 = Lower (b)
Mode Default Messages Altered	Mode 3 X *****	O O O	
Note Number: True voice	28-103 *****	0-127 X	
Velocity Note ON Note OFF	O X	O O	
After Touch Key's Ch's	X O	O O	
Pitch Bender	O	O	(c)
Control Change	O	O	(c)
Prog change: True #	1-128 *****	1-128 X	
System Exclusive	O	O	
System : Song Pos : Song Sel Common : Tune	X X X	O O O	
System Real Time : Clock : Commands	O O	O O	Midi File Record/Play Midi File Record/Play
Aux Messages : Local ON/OFF : All Notes OFF : Active Sense : Reset	X X O X	X O O X	
Notes	(a) = Factory Setup (b) = Memorized (c) = Message are TX over particular conditions		Messages recognized from MIDI In are retransmitted on MIDI Out merged with the messages generated by the A-33 with no effect on A-33 performances.

Mode 1: OMNI ON, POLY
Mode 3: OMNI OFF, POLY

Mode 2: OMNI ON, MONO
Mode 4: OMNI OFF, MONO

O: YES
X: NO

A-33 MIDI KEYBOARD CONTROLLER

MIDI IMPLEMENTATION

Version 1.0

Date: January 1996

1 RECEIVE DATA

All recognized MIDI messages from MIDI-IN are retransmitted on MIDI-OUT, with no effect on internal A-33 performance, except the the A-33 Patch SYS-EXE messages that are used to modify the A-33 Patch parameter area.
Refer to "Exclusive Communication" description.

Status	Second	Third
BnH	07H	vvH

n=MIDI channel number: 0H - FH (ch.1 - ch.16)
vv=Volume : 00H - 7FH (0 - 127)

2 TRANSMIT DATA

Channel Voice Message -

■ Note off

Status	Second	Third
9nH	kkH	00H

n=MIDI channel number : 0H - FH (ch.1 - ch.16)
kk=Note number : 00H - 7FH (0 - 127)
vv=Velocity : 00H (0)

■ Note on

Status	Second	Third
9nH	kkH	vvH

n=MIDI channel number : 0H - FH (ch.1 - ch.16)
kk=Note number : 00H - 7FH (0 - 127)
vv=Velocity : 01H - 7FH (1 - 127)

■ Control change

Bank select

Status	Second	Third
BnH	00H	mmH
BnH	20H	11H

n=MIDI channel number : 0H - FH (ch.1 - ch.16)
mm, 11=Bank number : 00H,00H - 7FH,7FH (bank1 - bank16384)

Channel Pressure (Channel Aftertouch)

Status	Second
DnH	kkH

n=MIDI channel number : 0H - FH (ch.1 - ch.16)
kk=value : 00H - 7FH (0 - 127)

Modulation

Status	Second	Third
BnH	01H	vvH

n=MIDI channel number : 0H - FH (ch.1 - ch.16)
vv=Modulation depth : 00H - 7FH (0 - 127)

Volume

Panpot

Status	Second	Third
BnH	0AH	vvH

n=MIDI channel number:0H - FH (ch.1 - ch.16)
vv=Panpot:00H - 40H - 7FH (Left - Center - Right)

Hold1

Status	Second	Third
BnH	40H	vvH

n=MIDI channel number : 0H - FH (ch.1 - ch.16)
vv=Control Value : 00H - 7FH (0 - 127) 0-63=OFF, 64-127=ON

■ Effect1 depth (Reverb send level)

Status	Second	Third
BnH	5BH	vvH

n=MIDI channel number : 0H - FH (ch.1 - ch.16)
vv=Reverb send level: 00H - 7FH (0 - 127)

*Effect1 depth messages control the Send Level of the specified channel (part) to the internal Reverb unit.

■ Effect3 depth (Chorus send level)

Status	Second	Third
BnH	5DH	vvH

n=MIDI channel number : 0H - FH (ch.1 - ch.16)
vv=Chorus send level: 00H - 7FH (0 - 127)

*Effect3 depth messages control the Send Level of the specified channel (part) to the internal Chorus unit.

■ Program change

Status	Second
CnH	ppH

n=MIDI channel number : 0H - FH (ch.1 - ch.16)
pp=Program number : 00H - 7FH (prog.1 - prog.128)

■ Pitch bend change

Status	Second	Third
EnH	11H	mmH

n=MIDI channel number : 0H - FH (ch.1 - ch.16)
mm, 11=Value : 00 00H - 40 00H - 7F 7FH (-8192 - 0 - +8191)

System Realtime Message

Active sensing

Status
FEH

*Transmits at about 300ms intervals.

Sequencer start

Status
FAH

*Transmitted if "Start/Stop" button is pressed.

Sequencer stop

Status
FCH

*Transmitted if "Start/Stop" button is pressed.

Timing clock

Status
FBH

*Timing clock is always transmitted if it "F8 Clock Int".

A-33 Patch Area

Address(H)	SIZE(H)	Description
00 00 00H	00 00 10 #	PATCH-1
00 00 10H	00 00 10 #	PATCH-2
00 00 20H	00 00 10 #	PATCH-3
00 00 30H	00 00 10 #	PATCH-4
00 00 40H	00 00 10 #	PATCH-5
00 00 50H	00 00 10 #	PATCH-6
00 00 60H	00 00 10 #	PATCH-7
00 00 70H	00 00 10 #	PATCH-8
00 00 00H	00 00 10 #	PATCH-9
00 00 10H	00 00 10 #	PATCH-10
00 00 20H	00 00 10 #	PATCH-11
00 00 30H	00 00 10 #	PATCH-12
00 00 40H	00 00 10 #	PATCH-13
00 00 50H	00 00 10 #	PATCH-14
00 00 60H	00 00 10 #	PATCH-15
00 00 70H	00 00 10 #	PATCH-16
00 00 00H	00 00 10 #	PATCH-17
00 00 10H	00 00 10 #	PATCH-18
00 00 20H	00 00 10 #	PATCH-19
00 00 30H	00 00 10 #	PATCH-20
00 00 40H	00 00 10 #	PATCH-21
00 00 50H	00 00 10 #	PATCH-22
00 00 60H	00 00 10 #	PATCH-23
00 00 70H	00 00 10 #	PATCH-24
00 00 00H	00 00 10 #	PATCH-25
00 00 10H	00 00 10 #	PATCH-26
00 00 20H	00 00 10 #	PATCH-27
00 00 30H	00 00 10 #	PATCH-28
00 00 40H	00 00 10 #	PATCH-29
00 00 50H	00 00 10 #	PATCH-30
00 00 60H	00 00 10 #	PATCH-31
00 00 70H	00 00 10 #	PATCH-32

System Exclusive Message

■ Data Transfer

A-33 transmits "Data set 1 (DT1)" message when Data Dump Function is activated.

■ Data set 1 DT1 (12H)

Status	Data Byte	Description	Status
F0H	41H, 10H, 02H, 12H, aaH, bbH, ccH, ddH, ... eeH, sum		F7H
F0H		Exclusive status	
41H		Manufacturer's ID (Roland)	
10H		Device ID (dev => 10H)	
00H		Model ID (MSB) (Model A-33)	
02H		Model ID (LSB)	
12H		Command ID (DT1)	
aaH		Address MSB	
bbH		Address	
ccH		Address LSB	
ddH		Data	
:		:	
eeH		Data	
sum		Checksum	
F7H		EOX (End of exclusive)	

*Refer to Section 4 to calculate a Checksum.

Every A-33 Patch data SYS-EXE must include two data bytes only. The two data bytes represent one A-30 PATCH data byte nibblized. Two A-33 data PATCH Sys-EXEs must be sent/received with a time interval more than 30 ms.

3 A-33 Parameter address Map

[Bulk Dump

You can send or receive bulk data which contains a large amount of parameter data by using Bulk Dump communication.

It is used for storing bulk data in a sequencer or a computer.

To send several packets of large DT1 messages at a time, insert intervals of at least 40ms in between those packets.

This map indicates address, size, Data (range), Parameter, Description, and Default Value of parameters which can be transferred using Data Dump function.

All the numbers of address, size, Data, and Default Value are indicated in 7-bit Hexadecimal-form.

A-33 Patch Structure

Address(H)	Description	Bit	Value
00 00 H	Transpose Value	bit 7-3	-5/+6
	Transpose On/Off	bit 2	
	Velocity sensitivity	bit 1-0	H, L, M
00 01H	Tempo in BPM	bit 7-0	20-250
00 02H	Clock	bit 7	0=external / 1=Internal
	Upper Octave	bit 5-3	-2,+2
	Lower Octave	bit 2-0	-2,+2
00 03H	Lever Assign	bit 7	0=Modulation / 1=Aftertouch
	Split On/Off	bit 6	On/Off
	Split Value	bit 5-0	0-60
00 04H	Data Entry Assign	bit 7-0	0-255
00 05H	Upper Sust. Tx On/Off	bit 7	
	Upper CC 00 Value	bit 6-0	0-127
00 06H	Upper PB&Lev TX On/Off	bit 7	
	Upper CC 20 Value	bit 6-0	0-127
00 07H	Upper Reverb On/Off	bit 7	
	Upper Program Change Value	bit 6-0	0-127
00 08H	Upper Exp. Pedal TX On/Off	bit 7	
	Lower Exp. Pedal TX On/Off	bit 6	
	Upper Keyboard Mode On/Off	bit 5	
	Lower Keyboard Mode On/Off	bit 4	
	Upper TX MIDI Channel	bit 3-0	0-15
00 09H	Lower Sustain TX On/Off	bit 7	
	Lower CC 00 Value	bit 6-0	0-127
00 0AH	Lower PB&Lev TX On/Off	bit 7	
	Lower CC 20 Value	bit 6-0	0-127
00 0BH	Lower Reverb On/Off	bit 7	
	Lower Program Change Value	bit 6-0	0-127
00 0CH	MIDI Out 1 On/Off	bit 7	
	MIDI Out 2 On/Off	bit 6	
	Upper Chorus On/Off	bit 5	
	Lower Chorus On/Off	bit 4	
	Lower TX MIDI Channel	bit 3-0	0-15
00 0DH	Lower Volume	bit 7-4	0-127
	Upper Volume	bit 3-0	0-127
00 0EH	Lower Reverb	bit 7-4	0-127
	Upper Reverb	bit 3-0	0-127
00 0FH	Lower Chorus	bit 7-4	0-127
	Upper Chorus	bit 3-0	0-127

Decimal and Hexadecimal

It is common to use 7-bit Hexadecimal numbers in MIDI communication. The following is a conversion table between decimal numbers and 7-bit Hexadecimal numbers.

Decimal	Hexa-decimal	Decimal	Hexa-decimal	Decimal	Hexa-decimal	Decimal	Hexa-decimal
0	00H	32	20H	64	40H	96	60H
1	01H	33	21H	65	41H	97	61H
2	02H	34	22H	66	42H	98	62H
3	03H	35	23H	67	43H	99	63H
4	04H	36	24H	68	44H	100	64H
5	05H	37	25H	69	45H	101	65H
6	06H	38	26H	70	46H	102	66H
7	07H	39	27H	71	47H	103	67H
8	08H	40	28H	72	48H	104	68H
9	09H	41	29H	73	49H	105	69H
10	0AH	42	2AH	74	4AH	106	6AH
11	0BH	43	2BH	75	4BH	107	6BH
12	0CH	44	2CH	76	4CH	108	6CH
13	0DH	45	2DH	77	4DH	109	6DH
14	0EH	46	2EH	78	4EH	110	6EH
15	0FH	47	2FH	79	4FH	111	6FH
16	10H	48	30H	80	50H	112	70H
17	11H	49	31H	81	51H	113	71H
18	12H	50	32H	82	52H	114	72H
19	13H	51	33H	83	53H	115	73H
20	14H	52	34H	84	54H	116	74H
21	15H	53	35H	85	55H	117	75H
22	16H	54	36H	86	56H	118	76H
23	17H	55	37H	87	57H	119	77H
24	18H	56	38H	88	58H	120	78H
25	19H	57	39H	89	59H	121	79H
26	1AH	58	3AH	90	5AH	122	7AH
27	1BH	59	3BH	91	5BH	123	7BH
28	1CH	60	3CH	92	5CH	124	7CH
29	1DH	61	3DH	93	5DH	125	7DH
30	1EH	62	3EH	94	5EH	126	7EH
31	1FH	63	3FH	95	5FH	127	7FH

*To indicate a decimal number for the MIDI channel, Bank number, and Program number, add one to the values in the table.
*The resolution of 7-bit Hexadecimal numbers is 128. Use several bytes for values which require more resolution.

i.e. The number "ad bbH" in 7-bit Hexadecimal is "ad x 128 + bb" in Decimal form.
*A signed number (with a sign +/-) is indicated as 00H = -64, 40H = 0, 7FH = +63.
So the signed number "aaH" in 7-bit Hexadecimal is "ad - 64" (ad is the decimal number of aaH).
In case of two bytes, it is regarded as 00 00H = -8192, 40 00H = 0, 7F 7FH = +8191.

So the signed number "ad bbH" in 7-bit Hexadecimal is "ad bbH - 40 00H = ad x 128 + bb - 64 x 128", where, ad and bb is the decimal number of aaH and bbH respectively.

*The data indicated as "nibbled" is a 4-bit Hexadecimal number.
i.e. "0a 0bH" is "a x 16 + b".

<Example 1> Convert "5AH" in Hexadecimal to a Decimal number.
(By using the table) 5AH = 90

<Example 2> Convert "12 34H" in 7-bit Hexadecimal to a Decimal number.
(By using the table) 12H = 18, 34H = 52
So, 18 x 128 + 52 = 2356

<Example 3> Convert "0A 03 09 0D" in nibbled form to a Decimal number.
(By using the table) 0AH = 10, 03H = 3, 09H = 9, 0DH = 13
So, ((10 x 16 + 3) x 16 + 9) x 16 + 13 = 41885

Example of actual MIDI messages

<Example 1> 92 3E 5F

"9n" is a status of a Note On message, and "n" is a MIDI channel number. The second byte is a Note number, and the third is Velocity.
2H = 2, 3EH = 62, 5FH = 95
So, this is a Note On message of MIDI channel=3, Note number=62(D4) and Velocity=95.

<Example 2> CE 49

"Cn" is a status of a Program change message, and "n" is a MIDI channel number. The second byte is a Program number.
EH = 14, 49H = 73
So, this is a Program change message of MIDI channel=15, Program number= 74 (Flute in GS).

<Example 3> EA 00 28

"EnH" is a status of a Pitch bend change message, and "n" is a MIDI channel number. The second byte (00H) is an LSB and the third (28H) is an MSB of a Pitch bend value (signed).

The Pitch bend value is:

$28\ 00H - 40\ 00H = 40 \times 128 + 0 - (64 \times 128 + 0) = 5120 - 8192 = -3072$
So, this is a Pitch bend change message of MIDI channel=11,
Pitch bend value = -3072

If the Pitch bend sensitivity is set to 2 semitones, and the Pitch bend value -8192 (00 00H) is defined as -200 cents,
The actual pitch bend value of this message is: $-200 \times (-3072) / (-8192) = -75$ cent

<Example 4> B3 64 00 65 00 06 0C 26 00 64 7F 65 7F

"Bn" is a status of a Control change message, and "n" is a MIDI channel number. The second byte is a Control number and the third is the value.
This packet uses the running status rule, that is, when you send a series of messages with the same status, you can omit the following status bytes.
This message contains :

B3 64 00 MIDI CH = 4 LSB of RPN parameter number : 00H
(B3) 65 00 MIDI CH = 4 MSB of RPN parameter number : 00H
(B3) 06 0C MIDI CH = 4 MSB of Data entry : 0CH
(B3) 26 00 MIDI CH = 4 LSB of Data entry : 00H
(B3) 64 7F MIDI CH = 4 LSB of RPN parameter number : 7FH
(B3) 65 7F MIDI CH = 4 MSB of RPN parameter number : 7FH

This message string means 'send data "0C 00H" to RPN parameter number"00 00H", after that, set RPN parameter number to "7F 7F".

RPN parameter number "00 00H" is Pitch bend sensitivity and the unit of the MSB value is a semitone, so 0CH = 12 is a value to set the Pitch bend sensitivity = 12 semitones (one octave).
GS devices ignore the LSB value of Pitch bend sensitivity. However, you had better send both MSB and LSB(=00H) to maintain data compatibility.

Once an RPN or NRPN number is set, all the Data entry messages sent after are effective.

Sometimes this rule may cause a problem if the MIDI data is played by a sequencer and it is operated in fast forward or backward mode. It is recommended, therefore, to set the RPN or NRPN number to 7F 7FH after sending the Data entry messages.

*To use running-status for several MIDI event like <example 4> in a song data (e.g. Standard MIDI File data) is not recommended.

There may be a sequencer which can not handle such data correctly when it is operated in fast forward or backward. Putting the status byte for every event is the reliable way.

*The parameter number and the value of RPN or NRPN must be sent in correct order. As some sequencers may send those recorded data in different order if an event is too close to another, it is recommended to place each event in a different tick. (1-CLK for TPQN=92, or 5-CLK for TPQN=480 is recommended.)

The send order may be different as each sequencer if the events are in the same clock in sequence data.

Checksum of Roland System Exclusive messages

Roland System Exclusive messages (RQ1 and DT1) have a Checksum at the end of the data (just before EOX) to be able to check for communication errors.

The Checksum is determined by values of address and data (or size) included in the message.

<How to calculate Checksums> ("H" indicates Hexadecimal.)

The error checking process employs a sum-check error detection. It provides binary bit figures whose lower 7 bits are zero when values for an address, data (or size) and the Checksum are summed.

One practical equation to determine Checksum is:

If the address is "ad bb ccH" and the data(or the size) is "dd ee ffH"

$ad + bb + cc + dd + ee + ff = \text{sum}$

$\text{sum} / 128 = \text{quotient and remainder}$

$128 \cdot \text{remainder} = \text{checksum}$

<Example 1> Set "REVERB MACRO" to "ROOM 3"

According to the Parameter Address Map, the Address of REVERB MACRO is 40 01 30H, and the Value correspond to ROOM 3 is 02H.

So, the message should be :

F0 41 10 42 12 40 01 30 02 ?? F7 (1)Exclusive Status (4)Model ID (GS)
(2)ID (Roland) (5)Command ID (DT1)
(1)(2)(3)(4)(5) address data checksum (6) (3)Device ID (16) (6)End of Exclusive

The Checksum is :

$40H + 01H + 30H + 02H = 64 + 1 + 48 + 2 = 115(\text{sum})$

$115(\text{sum}) / 128 = 0(\text{quotient}) 115(\text{remainder})$

$\text{checksum} = 128 - 115(\text{remainder}) = 13 = 0DH$

Therefore, the message to send is : F0 41 10 42 12 40 01 30 02 0D F7

<Example 2> To request LEVEL of NOTE NUMBER 75(D#5; Claves) in DRUM MAP 1

NOTE NUMBER 75(D#5) is 4BH in Hexadecimal.

The Address of "LEVEL of NOTE NUMBER 75(D#5; Claves) in DRUM MAP 1" is 41 02 4BH, and the size is 00 00 01H. So, the message should be :

F0 41 10 42 11 41 02 4B 00 00 01 ?? F7 (1)Exclusive Status (4)Model ID (GS)
(2)ID (Roland) (5)Command ID (RQ1)
(1)(2)(3)(4)(5) address data checksum (6) (3)Device ID (16) (6)End of Exclusive

The Checksum is :

$41H + 02H + 4BH + 00H + 00H + 01H = 65 + 2 + 75 + 0 + 0 + 1 = 143(\text{sum})$

$143(\text{sum}) / 128 = 1(\text{quotient}) 15(\text{remainder})$

$\text{checksum} = 128 - 15(\text{remainder}) = 113 = 71H$

Therefore, the message to send is : F0 41 10 42 11 41 02 4B 00 00 01 71 F7

<Example 3> Set "MASTER TUNE" to +23.4 cents by System Exclusive

The Address of "MASTER TUNE" is 40 00 00H, and the Size is 00 00 04H.

The Value should be nibblized data whose resolution is 0.1 cents, and which is a signed value

(00 04 00 00H (= 1024) = 0).

$+23.4[\text{cents}] = 234 + 1024 = 1258 = (\text{hexadecimal}) \Rightarrow 04 \text{ EAH} = (\text{nibblized}) \Rightarrow 00 04 0E 0AH$

So, the message should be :

F0 41 10 42 12 41 00 00 00 04 0A ?? F7 (1)Exclusive Status (4)Model ID (GS)
(2)ID (Roland) (5)Command ID (DT1)
(1)(2)(3)(4)(5) address data checksum (6) (3)Device ID (16) (6)End of Exclusive

The Checksum is :

$41H + 00H + 00H + 00H + 04H + 0EH + 0AH = 65 + 0 + 0 + 0 + 4 + 14 + 10 = 93(\text{sum})$

$93(\text{sum}) / 128 = 0(\text{quotient}) 93(\text{remainder})$

$\text{checksum} = 128 - 93(\text{remainder}) = 35 = 23H$

Therefore, the message to send is : F0 41 10 42 11 41 00 00 00 04 0E 0A 23 F7

Information

When you need repair service, call your nearest Roland Service Center or authorized Roland distributor in your country as shown below.

AFRICA

EGYPT

Al Fanny Trading Office
P.O. Box 2904,
El Horrieh Heliopolos, Cairo,
EGYPT
TEL: (02) 4185531

REUNION

Maison FO - YAM Marcel
25 Rue Jules Mermet
Chaudron - BP79 97491
Ste Clotilde REUNION
TEL: 28 29 16

SOUTH AFRICA

**That Other Music Shop
(PTY) Ltd.**

11 Melle Street (Cnr Melle and
Juta Street)
Braamfontein 2001
Republic of SOUTH AFRICA
TEL: (011) 403 4105

Paul Bothner (PTY) Ltd.

17 Werdmuller Centre Claremont
7700
Republic of SOUTH AFRICA

P.O. Box 23032
Claremont, Cape Town
SOUTH AFRICA, 7735
TEL: (011) 64 4030

ASIA

CHINA

**Beijing Xinghai Musical
Instruments Co., Ltd.**
6 Huangmunchang Chao Yang
District, Beijing, CHINA
TEL: (010) 6774 7491

HONG KONG

**Tom Lee Music Co., Ltd.
Service Division**
22-32 Fun Shan Street, Tsuen
Wan, New Territories,
HONG KONG
TEL: 2415 0911

INDIA

Rivera Digitec (India) Pvt. Ltd.
409, Nirman Kendra Mahalaxmi
Flats Compound Off. Dr. Edwin
Moses Road, Mumbai-400011,
INDIA
TEL: (022) 498 3079

INDONESIA

PT Citra Inti Rama
Jl. Cideng Timur No. 15J-150
Jakarta Pusat
INDONESIA
TEL: (021) 6324170

KOREA

**Cosmos Corporation
Service Station**
261 2nd Floor Nak-Won Arcade
Jong-Ro ku, Seoul, KOREA
TEL: (02) 742 8844

MALAYSIA

Bentley Music SDN BHD
140 & 142, Jalan Bukit Bintang
55100 Kuala Lumpur, MALAYSIA
TEL: (03) 2443333

PHILIPPINES

G.A. Yupangco & Co. Inc.
339 Gil J. Puyat Avenue
Makati, Metro Manila 1200,
PHILIPPINES
TEL: (02) 899 9801

SINGAPORE

Swee Lee Company
150 Sims Drive,
SINGAPORE 387381
TEL: 748-1669

CRISTOFORI MUSIC PTE LTD

Blk 3014, Bedok Industrial Park E,
#02-2148, SINGAPORE 489980
TEL: 243 9555

TAIWAN

**ROLAND TAIWAN
ENTERPRISE CO., LTD.**
Room 5, 9fl. No. 112 Chung Shan
N. Road Sec. 2, Taipei, TAIWAN,
R.O.C.
TEL: (02) 2561 3339

THAILAND

Theera Music Co., Ltd.
330 Veng Nakorn Kasem, Soi 2,
Bangkok 10100, THAILAND
TEL: (02) 2248821

VIETNAM

Saigon Music
138 Tran Quang Khai St.,
District 1
Ho Chi Minh City
VIETNAM
TEL: (08) 844-4068

AUSTRALIA/ NEW ZEALAND

AUSTRALIA

**Roland Corporation
Australia Pty., Ltd.**
38 Campbell Avenue
Dee Why West, NSW 2099
AUSTRALIA
TEL: (02) 9982 8266

NEW ZEALAND

Roland Corporation (NZ) Ltd.
97 Mt. Eden Road, Mt. Eden,
Auckland 3, NEW ZEALAND
TEL: (09) 3098 715

CENTRAL/LATIN AMERICA

ARGENTINA

Instrumentos Musicales S.A.
Florida 656 2nd Floor
Office Number 206A
Buenos Aires
ARGENTINA, CP1005
TEL: (54-11) 4-393-6057

BRAZIL

Roland Brasil Ltda.
R. Coronel Octaviano da Silveira
203 05522-010
Sao Paulo BRAZIL
TEL: (011) 3743 9377

CHILE

Comercial Fancy S.A.
Avenida Rancagua # 0330
Providencia Santiago, CHILE
TEL: 56-2-373-9100

EL SALVADOR

OMNI MUSIC
75 Avenida Notre y Alameda
Juan Pablo 2 No. 4010
San Salvador, EL SALVADOR
TEL: (503) 262-0788

MEXICO

Casa Veerkamp, s.a. de c.v.
Av. Toluca No. 323 Col. Olivar de
los Padres 01780 Mexico D.F.
MEXICO
TEL: (525) 668 04 80

La Casa Wagner de

Guadalajara s.a. de c.v.
Av. Corona No. 202 S.J.
Guadalajara, Jalisco Mexico
C.P. 44100 MEXICO
TEL: (3) 613 1414

PANAMA

Productos Superiores, S.A.
Apartado 655 - Panama 1
REP. DE PANAMA
TEL: (507) 270-2200

URUGUAY

Todo Musica
Cuareim 1488, Montevideo,
URUGUAY
TEL: 5982-924-2335

VENEZUELA

Musicland Digital C.A.
Av. Francisco de Miranda,
Centro Parque de Cristal, Nivel
C2 Local 20 Caracas
VENEZUELA
TEL: (02) 285 9218

EUROPE

AUSTRIA

Roland Austria GES.M.B.H.
Siemensstrasse 4, P.O. Box 74,
A-6063 RUM, AUSTRIA
TEL: (0512) 26 44 260

BELGIUM/HOLLAND/ LUXEMBOURG

Roland Benelux N. V.
Houtstraat 3 B-2260 Oevel
(Westerlo) BELGIUM
TEL: (014) 575811

DENMARK

Roland Scandinavia A/S
Nordhavnsvej 7, Postbox 880
DK-2100 Copenhagen
DENMARK
TEL: (039)16 6200

FRANCE

Roland France SA
4, Rue Paul Henri SPAAK
Parc de l'Esplanade F 77 462 St.
Thibault Lagny Cedex FRANCE
TEL: 01 600 73 500

FINLAND

**Roland Scandinavia As,
Filial Finland**
Lautasaarentie 54 B
Fin-00201 Helsinki, FINLAND
TEL: (9) 682 4020

GERMANY

**Roland Elektronische
Musikinstrumente
Handelsgesellschaft mbH.**
Oststrasse 96, 22844 Norderstedt,
GERMANY
TEL: (040) 52 60990

GREECE

STOLLAS S.A.
Music Sound Light
155, New National Road
26422 Patras, GREECE
TEL: 061-435400

HUNGARY

Intermusica Ltd.
Warehouse Area 'DEPO' Pf.83
H-2046 Torokbalint, HUNGARY
TEL: (23) 511011

IRELAND

Roland Ireland
Audio House, Belmont Court,
Donnybrook, Dublin 4,
Republic of IRELAND
TEL: (01) 2603501

ITALY

Roland Italy S. p. A.
Viale delle Industrie, 8
20020 Arese Milano, ITALY
TEL: (02) 937-78300

NORWAY

**Roland Scandinavia Avd.
Kontor Norge**
Lilleakerveien 2 Postboks 95
Lilleaker N-0216 Oslo
NORWAY
TEL: 273 0074

POLAND

P. P. H. Brzostowicz
Ul. Gibraltarska 4,
PL-03664 Warszawa POLAND
TEL: (022) 679 44 19

PORTUGAL

**Tecnologias Musica e Audio,
Roland Portugal, S.A.**
RUA SANTA CATARINA
131 - 4000 Porto -PORTUGAL
TEL: (02) 208 44 56

ROMANIA

FBS LINES
Plata Libertatii 1,
RO-4200 Cheorgheni
TEL: (066) 164-609

RUSSIA

Slami Music Company
Sadovaya-Triumfalnaja st., 16
103006 Moscow, RUSSIA
TEL: 095 209 2193

SPAIN

**Roland Electronics
de España, S. A.**
Calle Bolivia 239 08020 Barcelona,
SPAIN
TEL: (93) 308 1000

SWEDEN

**Roland Scandinavia A/S
SWEDISH SALES OFFICE**
Danvik Center 28, 2 tr.
S-131 30 Nacka SWEDEN
TEL: (08) 702 0020

SWITZERLAND

**Roland (Switzerland) AG
Musitronic AG**
Gerberstrasse 5, CH-4410 Liestal,
SWITZERLAND
TEL: (061) 921 1615

UKRAINE

TIC-TAC
Mira Str. 19/108
P.O. Box 180
295400 Munkachevo, UKRAINE
TEL: (03131) 414-40

UNITED KINGDOM

Roland (U.K.) Ltd.
Atlantic Close, Swansea
Enterprise Park SWANSEA
SA7 9FJ,
UNITED KINGDOM
TEL: (01792) 700139

MIDDLE EAST

BAHRAIN

Moon Stores
Bab Al Bahrain Road,
P.O. Box 20077
State of BAHRAIN
TEL: 211 005

CYPRUS

Radex Sound Equipment Ltd.
17 Diagorou St., P.O. Box 2046,
Nicosia CYPRUS
TEL: (02) 453 426

ISRAEL

**Haliit P. Greenspoon &
Sons Ltd.**
8 Retzif Fa'aliya Hashnya St.
Tel-Aviv-Yahoe ISRAEL
TEL: (03) 6823666

JORDAN

AMMAN Trading Agency
Prince Mohammed St. P.O. Box
825 Amman 11118 JORDAN
TEL: (06) 4641200

KUWAIT

Easa Husain Al-Yousifi
P.O. Box 126 Safat 13002
KUWAIT
TEL: 5719499

LEBANON

A. Chahine & Fils
P.O. Box 16-5857 Gergi Zeidan St.
Chahine Building, Achrafieh
Beirut, LEBANON
TEL: (01) 335799

OMAN

**OHI Electronics & Trading
Co. LLC**
P.O. Box 889 Muscat
Sultanate of OMAN
TEL: 959085

QATAR

Badie Studio & Stores
P.O. Box 62,
DOHA QATAR
TEL: 423554

SAUDI ARABIA

**aDawlah Universal
Electronics APL**
P.O. Box 2154 ALKHOBAR 31952,
SAUDI ARABIA
TEL: (03) 898 2081

SYRIA

**Technical Light & Sound
Center**
Khaled Ibn Al Walid St.
P.O. Box 13520
Damascus - SYRIA
TEL: (011) 2235 384

TURKEY

**Barkat Muzik aletleri ithalat
ve ihracat limited ireketi**
Siraselviler Cad. Billurcu Sok.
Mucadelle Cikmeze No. 11-13
Taksim. Istanbul, TURKEY
TEL: (0212) 2499324

U.A.E.

**Zak Electronics & Musical
Instruments Co.**
Zabeel Road, Al Sherqoq Bldg.,
No. 14, Grand Floor DUBAI
U.A.E.
P.O. Box 8050 DUBAI, U.A.E.
TEL: (04) 360715

NORTH AMERICA

CANADA

**Roland Canada Music Ltd.
(Head Office)**
5480 Parkwood Way Richmond
B. C. V6V 2M4 CANADA
TEL: (0604) 270 6626

Roland Canada Music Ltd.

(Toronto Office)
Unit 2, 109 Woodbine Downs
Blvd, Etobicoke, ON
M9W 6Y1 CANADA
TEL: (0416) 213 9707

U. S. A.

Roland Corporation U.S.
5100 S. Eastern Avenue
Los Angeles, CA 90040-2938,
U. S. A.
TEL: (323) 890 3700

 Roland®

K6018217

UPC

K6018217

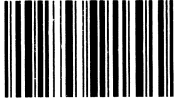

18981

A-33

RES 124-96 Printed in Italy by Amballi Grafiche s.r.l. - Ancona 99-07 - A-33 - OM-E-D-F-It

 Roland®

602153241

-2nd Edition-